

# 水路部観測報告

## 衛星測地編

第 2 号

平成元年 3 月

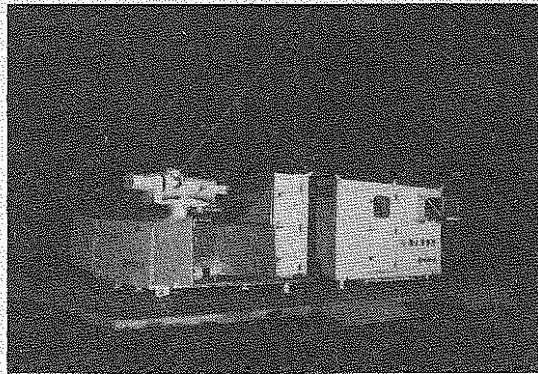

海上保安庁

DATA REPORT  
OF  
HYDROGRAPHIC OBSERVATIONS  
SERIES OF SATELLITE GEODESY .

No. 2, March 1989

CONTENTS

Satellite laser ranging observations in 1987 .....	1
Collocation observation between two SLR stations at the Simosato Hydrographic Observatory in 1987 .....	28
The new satellite camera for geodesy .....	50
Satellite data analysis computer system .....	59
Orbital prediction of AJISAI in 1987 .....	68
Geometric analysis of geodetic satellite data .....	72
GPS experiment in the Japan and France joint research program on rift system in the south pacific ocean (STARMER PROJECT).....	83

MARITIME SAFETY AGENCY  
TOKYO, JAPAN

**Compiled by the Hydrographic Department of Japan (JHD).**

**Inquiries as to this publication should be addressed to:**

**Hydrographic Department**

**Tsukiji-5, Chuo-ku, Tokyo,**

**104 Japan.**

DATA REPORT  
OF  
HYDROGRAPHIC OBSERVATIONS  
SERIES OF SATELLITE GEODESY

No. 2, March 1989

---

SATELLITE LASER RANGING OBSERVATIONS IN 1987

**Summary** – Satellite laser ranging observations have been continued by the fixed type satellite laser ranging system at the Simosato Hydrographic Observatory. The total numbers of returns obtained by this system in 1987 are 71,330 from 162 passes of Lageos, 18,514 from 77 passes of Starlette, and 170,671 from 277 passes of Ajisai, respectively. The range precisions estimated by polynomial fitting to measured range minus predicted range (O–C) are 10.0cm for Lageos, 11.5cm for Starlette, and 9.5cm for Ajisai.

**Key words:** satellite laser ranging – global geodesy.

This is a continuation of the report series of satellite laser ranging (SLR) observations obtained by the fixed type satellite laser ranging system at the Simosato Hydrographic observatory and contains the list of data obtained in 1987. Previous reports appear in Series of Astronomy and Geodesy, Data Report of Hydrographic Observations for the period from 1982–1985, and in Series of Satellite Geodesy for 1986. Routine observation by the Transportable Laser Ranging Station (called HTLRS, Sasaki 1988) was begun in December 1987, but data obtained by HTLRS will appear in the next volume of this series.

### 1. Observation

The routine ranging observation for Lageos, Starlette, and Beacon (BE)–C was begun in April 1982 by using the fixed type SLR system at the Simosato Hydrographic Observatory under mutual cooperation between the Hydrographic Department (JHD) and the National Aeronautics and Space Administration (NASA) of the United States of America. According to the launch of Japanese first Geodetic Satellite “Ajisai” in August 1986, observations for BE–C was terminated in July 1986. Lageos, Starlette and Ajisai has been observed routinely since August 1986.

The major specifications of the fixed type SLR system are listed in Table 1 (Sasaki *et al.*, 1983). The locations of the system and a fiducial stone marker set up near the system are shown in Table 2 (Takemura, 1983).

The observation schedule is made by selecting passes of maximum elevations of over 30 degrees of Lageos and Ajisai, over 40 degrees for daytime passes and over 45 degrees for night passes of Starlette, except daytime of both Saturday afternoon and Sunday. The priority of the selection for simultaneous transits is in the order of Ajisai, Lageos and Starlette.

The SAO-formatted orbital elements of the satellites for the use of scheduling and tracking are sent from Goddard Space Flight Center (GSFC) of NASA through telex until May and via GE Mark III network from June. The orbital elements of Ajisai are also calculated in the Head Office of JHD by using quick-look data which are sent from GSFC via GE Mark III network since the launch of the satellite. For the satellite tracking, an analytical tracking program using the elements are used. The tracking is carried out for elevation above 20 degrees. The atmospheric temperature, pressure and relative humidity are measured once in a pass. Before and after ranging to a satellite pass, the ranging calibration by using a ground target 1415m apart are made.

The total numbers of returns and passes obtained by the fixed type SLR system at the Simosato Hydrographic Observatory in 1987 are listed in Table 3.

As the master station of Loran C system (located at Iwo-Sima) stopped operation due to maintenance from February 13 to March 30, simulated signal for the master station was emitted from the simulator and the slave station Y (located at Okinawa) was measured by the receiver to keep time during this period. An international data communication network GE Mark III became in use in June. Overhaul and alteration of the laser ranging system was made from October 26 to November 30. Exchange of pump cavity, pockel cell driver board, isolator pockel cell, interference filter, etc. was carried out in overhaul. Two experts from GTE visited SHO and made checks and adjustments of the laser oscillator. In alteration an telescope of 28cm in aperture and 2.8m in focal length was added to the main telescope of the laser system and the apparatus to measure the timing of flashing of Ajisai was installed. Routine observation of the satellite laser ranging was continued as much as possible during this period.

## 2. Polynomial fitting and preliminary analysis of range data

The false range data are removed by visual rejection on a CRT screen and by applying the filter of polynomial fitting to measured range minus predicted range ( $O-C$ ) in use of on-site computer. Preliminary values of measurement standard deviation for each pass are estimated in this process.

A part of range data, quick-look (QL) data, is sent to GSFC within two days. The communication system was also changed from telex to GE Mark III network in the end of May. All the range data, named full rate (FR) data, after applied correction of the internal delay time of the SLR system obtained by the ground target ranging, are recorded on a magnetic tape together with satellite ID, station ID, transmitted time corrected into UTC (USNO MC), meteorological data, preliminary measurement standard deviation, clock precision and some preprocessing indications. The Seasat Decimal (SSD) Format (Schutz 1983) for the FR data was replaced by the MERIT II Format (CSTG, 1987) in June. The FR data on magnetic tapes for the three satellites are sent from the Simosato Hydrographic Observatory



to the Head Office of JHD, GSFC and the Center for Space Research (CSR) of the University of Texas.

As for the polynomial fitting using on-site computer, only the polynomials from 1st to 9th order can be applicable owing to insufficient size of memory. Sometimes waving residuals of period of around 1 minutes appear for low altitude satellites. It also became clear that many residuals of lower satellites contain wavings of shorter periods like 5–6 sec. To improve these situations polynomial fittings of the order from 1st to 20th are applied to all the range data by using ACOS 650 computer at the Head Office of JHD.

The weighted mean range precisions estimated by using the higher polynomial fitting for all the data obtained in 1987 are 10.0cm for Lageos, 11.5cm for Starlette and 9.5cm for Ajisai as shown in Table 3 instead of 10.0cm, 14.7cm and 10.0cm for the case of on-site fittings, respectively.

The QL data sent to GSFC are used to create new orbital elements. The data are transferred from GSFC to CSR and are used for estimation of the polar motion and variation of angular velocity of the earth rotation by processing with laser range data from other sites in the world. All the FR data are also analyzed in CSR and more precise values for earth rotation parameters have been estimated. The FR data sent to the Crustal Dynamics Project are used to detect crustal movements and international plate motions.

JHD has been processing a part of SLR data obtained at Simosato and other SLR sites by using an orbital processor (Sasaki, 1984a). A preliminary result of the geodetic coordinate for the cross point of azimuth and elevation axes of the SLR system at Simosato site, which is based on the longitude determined by the lunar laser ranging (LLR) observations at the McDonald Observatory, the University of Texas, is  $33^{\circ}34'39''.68N$ ,  $135^{\circ}56'13''.35E$ , 100.9 m for latitude, longitude and height above the reference ellipsoid of 6 378 137 m semi-major axis and  $1/298.257$  flattening, respectively (Sasaki, 1984b).

Calculations and compilation for this report have been made by T. Kanazawa, A. Sengoku and M. Nagaoka of JHD Head Office and H. Nakagawa of the Simosato Hydrographic Observatory.

### References

- Abshire, J. B. 1980: *NASA Report*, "Plan for Investigating Atmospheric Errors in Satellite Laser Ranging Systems".
- CSTG 1987: *Satellite Laser Ranging Newsletter* SLR subcommission of the CSTG (International Coordination of Space Techniques for Geodesy and Geodynamics) vol. 2, No. 1, p.5.
- Marini, J. W., Murray Jr., C. W. 1973: *NASA Report*, X-591-73-351, GSFC, Maryland.
- Sasaki, M., Ganeko, Y., Harada, Y. 1983: *Data Report of Hydrogr. Obs., Series of Astronomy and Geodesy*, No. 17, p.49.
- Sasaki, M. 1984a: *Report of Hydrogr. Researches*, No. 19, p.107.

- Sasaki, M. 1984b: *Jour. Geod. Soc. Japan*, vol. 30, p.29.
- Schutz, B. E. 1983: *Satellite Laser Ranging Procedures Guide for Project MERIT*, CSR, Univ. of Texas, Austin.
- Takemura, T. 1983: *Data Report of Hydrogr. Obs., Series of Astronomy and Geodesy*, No. 17, p.44.
- USNO 1987, 1988: *Daily Time Differences and Relative Phase Values, Series 4*, No. 1040-1091.

The reports of the SLR observations for the preceding years were presented in the following numbers of the Data Report of Hydrographic Observations.

- Sasaki, M., Nagaoka, M. 1984: *Data Report of Hydrogr. Obs., Series of Astronomy and Geodesy*, No. 18, p.55 (for 1982).
- Sasaki, M., Sengoku, A., Nishimura, E., Nagaoka, M. 1985: *ibid.*, No. 19, p.50 (for 1983).
- Sasaki, M., Sengoku, A., Nagaoka, M., Nishimura, E. 1986: *ibid.*, No. 20, p.44 (for 1984).
- Kanazawa, T., Sengoku, A., Nagaoka, M., Nishimura, E. 1987: *ibid.*, No. 21, p.63 (for 1985).
- Kanazawa, T., Sengoku, A., Nagaoka, M., Nishimura, E. 1988: *Data Report of Hydrogr. Obs., Series of Satellite Geodesy*, No. 1, p.19 (for 1986).

**Table 1. Principal specifications of the satellite laser ranging system at the Simosato Hydrographic Observatory**

Mount configuration	elevation over azimuth
Angular resolution	20 bits (1.2 arcsec)
Transmitter diameter	17 cm
Receiver diameter	60 cm
Laser wave length	532 nm
Output energy	150 mJ (normal)
Laser pulse width	200 ps
Repetition rate	4 pps
Receiver detector	PMT (9% Q.E. and 300 ps rise time)
Flight time counter	20ps resolution
Frequency standard	Rubidium oscillator
Time comparison	multi-Loran C waves (NW Pacific Chain)
Computer	PDP 11/60 (64 kw) with two disk- and a MT drives

**Table 2. Geodetic coordinates**

Location	Site ID	Coordinates (Tokyo Datum)
Cross point of AZ. and EL. axes, the SLR system at Simosato Hydrogr. Obs.	International	33° 34' 27.496 N
	7838	135 56 23.537 E
	Domestic SHO-L	62.44 m
Cross line, the fiducial stone marker at Simosato Hydrogr. Obs.	Domestic	33° 34' 28.078 N
	SHO-H0	135 56 23.236 E
		58.36 m

**Table 3. Data acquisition at the Simosato Hydrographic Observatory in 1987**

Satellite	No. of ranges	No. of passes	RMS deviation
Lageos	71,330	162	10.0 cm
Starlette	18,514	77	11.5
Ajisai	170,671	277	9.5
Observers	E. Nishimura, K. Koyama, K. Onodera, H. Sasaki, A. Masuyama, M. Sawa, H. Ito, H. Mori, K. Fuchida*		

\* temporary support from JHD Head Office



Table 4. Observations and data fitting

Column	Explanation
1, 8	Serial number of passes ranged successfully for each satellite.
2	Observation time (UTC) of the first return and the last return observed in the satellite pass.
3	Satellite identification (ID), LG: Lageos, ST: Starlette, AJ: Ajisai.
4	Azimuth when the tracking of the satellite started at 20° of elevation.
5	Elevations at the maximum, at the first return obtained and at the last return obtained in the satellite path. U means through the maximum elevation.
6	Number of successful returns from the satellite in the pass.
7	Order of the polynomials applied and the root mean square deviation of the curve fitting to measured range minus predicted range. Before the fitting applied an atmospheric correction (Marini and Murray, 1973) is added.

The range correction added to the measured range is

$$dR = -\frac{g(\lambda)}{f(\varphi, H)} \cdot \frac{A + B}{\sin E + \frac{B/(A+B)}{\sin E + 0.01}}$$

where

$$g(\lambda) = 0.9650 + \frac{0.0164}{\lambda^2} + \frac{0.000228}{\lambda^4},$$

$$f(\varphi, H) = 1 - 0.0026 \cos 2\varphi - 0.00031 H,$$

$$A = 0.002357 P + 0.000141 e,$$

$$B = (1.084 \times 10^{-8}) PTK + (4.734 \times 10^{-8}) \frac{P^2}{T} \cdot \frac{2}{(3 - 1/K)},$$

$$K = 1.163 - 0.00968 \cos 2\varphi - 0.00104 T + 0.00001435 P,$$

$$e = 6.11 \cdot \frac{Rh}{100} \cdot 10^{7.5(T-273.15)/\{237.3+(T-273.15)\}}$$

Here

dR : Range correction (meters),

E : True elevation of satellite,

P : Atmospheric pressure at the site (millibars),

T : Atmospheric temperature at the site (degrees Kelvin),

Rh : Relative humidity at the site (%),

$\lambda$  : Wavelength of the laser (microns),

$\varphi$  : Latitude of the site,

H : Altitude of the site (kilometers).

This term is not corrected for the measured range in the final MT file.

## Column

- 10 Atmospheric temperature (degrees Centigrade).  
 11 Atmospheric pressure (millibars).  
 12 Relative humidity (%).  
 13 Calibrated internal delay time of the SLR system obtained by the ground target ranging. The light velocity change in the air (Abshire, 1980) is used for the atmospheric correction. This term is corrected for the range data in the final MT file.

The group velocity of light in the air is given by

$$v = c \cdot (1 + 10^{-6} N)^{-1},$$

where

$$N = 80.343 \left( 0.9650 + \frac{0.0164}{\lambda^2} + \frac{0.00028}{\lambda^4} \right) \frac{P}{T} - 11.3 \frac{e}{T},$$

$$e = 6.11 \cdot \frac{Rh}{100} \cdot 10^{7.5(T-273.15)/\{237.3+(T-273.15)\}}.$$

Here

- c : The vacuum speed of light,  
 P : Atmospheric pressure (millibars),  
 T : Atmospheric temperature (degrees Kelvin),  
 Rh : Relative humidity (%),  
 $\lambda$  : Wavelength of the light (microns).

- 14 Time correction: Transmitting time of the Loran C North West Pacific (997) Chain minus time of the clock used in the SLR system. This term is corrected for the transmitted time in the final MT file.  
 15 Time correction: UTC (USNO MC) minus transmitting time of the Loran C North West Pacific (997) Chain (USNO, 1987, 1988). This term is corrected for the transmitted time in the final MT file.  
 16 Comments.

(1) No.	(2) Obs. Time(UTC)						(3) SAT.	(4)Az. ST	(5)Elev.			(6) RTN	(7)Fitting				
	date			caught					lost	MX	CT		LT	N	RMS		
	Y	M	D	h	m	s	h	m	s					cm			
1	87	01	06	13	49	24	14	31	20	LG	40R	50	23U	20	1320	9	10.3
2	87	01	06	17	20	42	17	58	32	LG	20L	50	21U	25	511	9	10.0
3	87	01	07	00	16	46	00	35	03	LG	110L	55	54U	35	52	5	10.3
4	87	01	08	02	24	35	02	29	06	LG	-200R	75	68	75	94	5	8.7
5	87	01	08	14	35	04	15	11	31	LG	30R	75	21U	44	1068	9	10.7
6	87	01	09	01	09	09	01	22	52	LG	130L	75	73U	40	267	9	10.5
7	87	01	09	13	17	15	13	43	03	LG	45R	40	24U	38	236	9	11.2
8	87	01	09	16	46	12	17	27	17	LG	20L	60	21U	24	812	9	10.6
9	87	01	12	16	11	35	16	54	52	LG	20L	85	21U	23	1480	9	11.4
10	87	01	13	14	51	03	15	36	02	LG	30R	85	26U	21	1691	20	11.8
11	87	01	14	13	29	23	14	11	16	LG	40R	50	23U	20	698	9	10.4
12	87	01	14	17	04	34	17	39	49	LG	20L	50	29U	22	435	9	11.7
13	87	01	15	15	38	14	16	23	13	LG	25L	75	23U	21	1154	9	11.3
14	87	01	19	13	41	29	14	27	02	LG	35R	60	21U	20	985	9	11.4
15	87	01	19	17	15	16	17	48	06	LG	20L	45	21U	28	449	7	11.1
16	87	01	20	12	24	49	12	57	15	LG	50R	35	22U	21	325	7	10.2
17	87	01	20	15	51	34	16	32	21	LG	20L	65	21U	29	992	9	11.7
18	87	01	21	14	34	54	15	04	25	LG	30R	85	35U	50	541	18	11.1
19	87	01	28	14	52	53	15	22	31	LG	25L	85	45U	38	356	9	10.2
20	87	01	27	13	23	15	13	39	56	LG	35R	60	25	59	177	7	8.5
21	87	01	27	16	55	50	17	26	13	LG	20L	45	22U	31	265	7	10.0
22	87	01	28	12	03	30	12	37	40	LG	50R	35	20U	20	369	9	10.9
23	87	01	28	15	37	12	16	15	44	LG	20L	65	33U	22	608	9	11.0
24	87	01	30	13	05	40	13	20	37	LG	40R	55	50U	41	177	7	7.9
25	87	01	30	16	38	53	16	55	54	LG	20L	50	50	30	312	7	13.1
26	87	02	04	13	01	07	13	15	25	LG	35R	65	20	51	197	9	10.4
27	87	02	04	16	34	52	17	11	45	LG	20L	45	20U	22	302	9	11.1
28	87	02	05	11	46	47	12	17	27	LG	50R	35	25U	21	359	9	11.0
29	87	02	05	15	17	56	15	55	36	LG	20L	65	35U	22	333	9	9.5
30	87	02	07	00	19	47	00	40	37	LG	145L	85	82	32	34	7	7.2
31	87	02	08	14	37	24	15	20	59	LG	25L	75	21U	26	611	9	10.9
32	87	02	09	01	02	01	01	07	21	LG	-200R	75	60	72	38	7	11.2
33	87	02	09	13	38	51	14	01	43	LG	30R	75	74	21	710	7	9.8
34	87	02	10	12	00	47	12	20	59	LG	45R	45	29U	41	348	7	9.9
35	87	02	10	15	26	27	16	07	23	LG	20L	55	21U	23	759	9	10.2
36	87	02	13	11	26	32	11	41	12	LG	50R	35	24	34	47	7	8.4
37	87	02	13	14	51	52	15	36	18	LG	20L	65	21U	20	676	9	12.4
38	87	02	14	01	32	08	01	40	10	LG	-190R	65	53	35	35	5	8.2
39	87	02	15	12	17	47	12	51	35	LG	40R	55	39U	20	908	19	10.7
40	87	02	20	12	24	38	13	06	59	LG	35R	65	27U	21	1068	9	12.1
41	87	02	20	16	03	09	16	27	20	LG	20L	45	34U	30	159	7	11.4
42	87	02	22	13	18	40	13	45	51	LG	25R	85	44U	46	623	19	11.3
43	87	02	23	11	56	53	12	19	39	LG	40R	55	37U	43	263	13	11.7
44	87	02	23	15	23	44	15	47	36	LG	20L	50	27U	44	120	7	10.1
45	87	02	25	12	46	08	13	20	21	LG	30R	75	47U	24	708	19	11.3
46	87	02	26	11	16	08	11	55	08	LG	45R	45	22U	21	375	9	10.9
47	87	02	27	13	24	10	14	08	55	LG	25L	85	23U	23	545	9	14.5
48	87	03	05	12	27	53	12	48	32	LG	30R	75	52U	53	602	15	10.3
49	87	03	08	11	57	20	12	19	35	LG	35R	65	55U	37	810	9	8.9
50	87	03	09	13	56	22	14	35	22	LG	20L	65	31U	22	690	9	9.4
51	87	03	11	11	21	37	11	51	33	LG	40R	55	46U	23	301	17	9.0
52	87	03	18	12	16	19	12	29	35	LG	25R	85	38	78	236	9	10.3
53	87	03	20	13	03	55	13	39	50	LG	25L	75	36U	28	220	7	10.4
54	87	03	24	11	17	13	11	31	54	LG	35R	65	55U	55	417	7	10.8
55	87	03	24	14	39	53	14	59	01	LG	20L	45	29U	40	117	7	8.9
56	87	03	25	13	25	59	13	34	40	LG	20L	65	53U	65	172	5	10.6
57	87	03	26	11	48	59	12	36	31	LG	25R	85	21U	20	1121	9	8.8
58	87	03	28	15	24	40	15	54	21	LG	15L	35	22U	20	181	11	9.0
59	87	03	31	12	11	02	12	40	07	LG	25L	85	39U	45	876	13	8.6
60	87	04	03	11	31	12	12	07	58	LG	25R	85	25U	41	698	9	9.1

SATELLITE LASER RANGING IN 1987

(8) No.	(9) STN	(10) TMP	(11) PRESS	(12) HUM	(13) IDT	(14) DTS	(15) DTL	(16) COMMENTS
		° C	mb	%	ns	µs	µs	
1	7838	4.8	1019.5	78	7.5	-0.5	-0.2	
2	7838	2.6	1020.4	87	7.6	-0.4	-0.2	
3	7838	7.4	1021.3	88	7.5	-0.4	-0.3	DAYTIME
4	7838	13.2	1008.8	45	7.5	-0.1	-0.3	DAYTIME
5	7838	6.7	1011.0	59	7.5	-0.6	-0.3	
6	7838	12.0	1011.2	54	7.6	-0.5	-0.3	DAYTIME
7	7838	8.9	1010.1	57	7.4	-0.5	-0.3	
8	7838	8.5	1010.4	53	7.5	-0.6	-0.3	
9	7838	4.9	993.5	61	7.7	-0.2	-0.4	
10	7838	1.2	1005.1	69	7.5	-0.4	-0.4	
11	7838	1.7	1016.0	72	7.4	-0.7	-0.5	
12	7838	0.8	1017.5	77	7.6	-0.6	-0.5	
13	7838	3.7	1020.8	78	7.7	-0.5	-0.5	
14	7838	1.7	1011.7	76	7.3	-0.6	-0.7	
15	7838	1.0	1011.9	72	7.5	-0.5	-0.7	
16	7838	1.9	1018.4	56	7.6	-0.4	-0.7	
17	7838	1.2	1019.7	58	7.5	-0.1	-0.7	
18	7838	2.9	1023.0	63	7.5	-0.2	-0.7	
19	7838	0.8	1019.5	73	7.3	-0.6	-0.8	
20	7838	5.7	1016.9	66	7.1	-0.7	-0.8	
21	7838	6.2	1016.5	50	7.1	-0.4	-0.8	
22	7838	5.7	1020.2	59	7.1	-0.4	-0.8	
23	7838	5.3	1020.2	58	7.2	-0.4	-0.8	
24	7838	7.0	1014.5	71	7.0	-0.6	-0.8	
25	7838	5.8	1014.1	75	7.2	-0.6	-0.8	
26	7838	1.8	1009.7	59	7.2	-0.3	-0.8	
27	7838	1.2	1009.9	70	7.2	-0.2	-0.8	
28	7838	4.1	1011.7	71	7.2	-0.3	-0.8	
29	7838	4.0	1012.5	69	7.2	-0.0	-0.8	
30	7838	11.2	1010.9	57	7.3	-0.7	-0.8	DAYTIME
31	7838	7.3	1016.5	56	6.9	-0.4	-0.8	
32	7838	13.5	1018.2	57	7.1	-0.6	-0.8	DAYTIME
33	7838	7.8	1017.3	71	7.1	-0.4	-0.8	
34	7838	11.0	1015.4	89	7.0	-0.4	-0.8	
35	7838	11.9	1014.8	86	7.1	-0.4	-0.8	
36	7838	8.2	1012.1	91	6.9	-0.4	-0.9	
37	7838	6.8	1012.0	93	7.2	-0.5	-0.9	
38	7838	16.8	1010.8	45	6.7	-0.5	-0.9	DAYTIME
39	7838	4.0	1015.8	72	6.8	-0.8	-0.9	
40	7838	5.3	1017.5	82	6.8	-0.6	-0.9	
41	7838	3.2	1018.0	61	6.9	-0.5	-0.9	
42	7838	3.9	1010.4	99	7.0	-1.1	-0.9	
43	7838	6.1	1011.7	64	5.7	-0.9	-0.9	
44	7838	5.3	1011.7	68	6.7	-0.8	-0.9	
45	7838	1.6	1009.7	56	6.6	-1.0	-0.8	
46	7838	2.6	1006.6	46	6.7	-1.0	-0.8	
47	7838	1.6	1001.2	66	6.6	-0.9	-0.8	
48	7838	10.3	1007.9	69	6.3	-0.5	-0.8	
49	7838	6.2	1011.4	86	6.2	-0.7	-0.8	
50	7838	4.6	1008.0	72	7.8	-0.9	-0.8	
51	7838	6.0	1007.1	76	7.6	-0.4	-0.8	
52	7838	9.8	1012.5	84	7.3	-0.5	-1.0	
53	7838	10.3	1009.5	70	7.3	-0.5	-1.0	
54	7838	16.5	996.5	60	7.3	-0.4	-1.1	
55	7838	13.0	999.7	60	7.4	-0.7	-1.1	
56	7838	5.1	1009.5	46	7.3	-0.8	-1.2	
57	7838	5.6	1018.9	47	7.5	-0.2	-1.2	
58	7838	2.5	1019.3	67	7.4	-0.4	-1.2	
59	7838	5.8	1013.6	56	7.4	-0.7	-1.3	
60	7838	9.6	1008.5	70	7.3	-0.5	-1.4	

(1) No.	(2) Obs. Time(UTC)						(3) SAT.	(4)Az. ST	(5)Elev.			(6) RTN	(7)Fitting		
	date			caught					lost	MX	CT		LT	N	RMS
	Y	M	D	h	m	s	h	m	s					cm	
61	87	04	13	12	07	05	12 24 08	LG	25L	75	43U	69	247	7	10.7
62	87	04	24	11	09	10	11 44 46	LG	25L	85	34U	33	726	9	9.6
63	87	04	29	11	32	06	11 59 58	LG	20L	75	57U	28	447	9	10.6
64	87	05	03	13	03	17	13 14 26	LG	20L	45	34U	42	69	7	11.2
65	87	05	04	11	55	21	12 13 26	LG	20L	65	63	26	281	7	10.4
66	87	05	06	12	37	11	12 52 07	LG	20L	50	47U	36	199	7	8.6
67	87	05	08	13	19	22	13 40 45	LG	15L	37	34U	24	32	7	11.4
68	87	05	24	12	36	59	12 56 04	LG	15L	37	31U	30	102	5	9.7
69	87	05	28	10	45	44	11 15 29	LG	20L	65	52U	22	889	9	9.0
70	87	06	04	11	41	31	11 54 55	LG	15L	45	31U	42	108	7	8.8
71	87	06	05	17	09	15	17 25 50	LG	95L	45	42U	35	130	7	8.7
72	87	06	16	16	18	25	16 36 03	LG	85L	40	39U	26	227	5	10.2
73	87	06	17	11	41	54	11 57 13	LG	15L	37	35U	29	290	5	9.5
74	87	06	21	16	45	43	16 54 11	LG	95L	45	35	20	175	7	9.2
75	87	06	22	08	29	59	08 31 37	LG	25R	85	79	85	33	5	7.9
76	87	06	22	18	24	14	18 51 59	LG	145L	85	34U	57	488	18	10.8
77	87	06	23	10	34	03	10 50 20	LG	20L	50	43	38	250	9	10.3
78	87	06	25	11	11	05	11 38 10	LG	15L	37	22U	27	162	7	10.5
79	87	06	25	17	55	26	18 31 50	LG	135L	80	46U	20	1226	16	9.5
80	87	06	26	16	39	16	17 06 32	LG	110L	50	44U	24	190	7	10.0
81	87	07	08	17	55	34	18 01 18	LG	145L	90	67	87	87	7	9.2
82	87	07	09	16	45	34	16 59 40	LG	120L	60	57	27	324	12	9.7
83	87	07	24	17	02	35	17 42 31	LG	145L	85	30U	28	454	9	11.4
84	87	07	28	15	21	22	15 47 25	LG	110L	55	48U	23	246	9	9.7
85	87	07	29	17	12	37	17 31 56	LG	-205R	80	21	72	305	17	9.5
86	87	08	06	13	51	48	13 58 58	LG	75L	35	35	29	18	5	8.9
87	87	08	11	14	04	19	14 09 35	LG	85L	40	40	36	49	7	10.6
88	87	08	12	16	14	20	16 30 57	LG	140L	80	67	22	193	7	11.5
89	87	08	16	17	30	29	18 07 17	LG	-185R	60	37U	21	390	18	10.4
90	87	08	17	06	08	35	06 12 38	LG	25R	90	74	88	62	7	9.1
91	87	08	17	16	12	58	16 46 15	LG	-215R	90	58U	20	271	17	9.3
92	87	08	19	13	32	22	13 48 51	LG	90L	40	34U	37	62	7	9.9
93	87	08	20	15	33	39	16 05 13	LG	140L	80	41U	36	120	7	10.0
94	87	08	21	14	15	17	14 42 36	LG	110L	55	37U	33	208	7	10.9
95	87	08	23	15	05	48	15 19 47	LG	130L	70	54U	64	59	7	9.6
96	87	08	26	14	35	21	14 58 22	LG	120L	60	55U	31	172	9	9.7
97	87	08	28	15	13	35	15 47 38	LG	140L	80	41U	30	489	16	8.9
98	87	08	31	14	44	06	15 14 05	LG	130L	70	50U	28	481	18	11.7
99	87	09	01	13	19	21	13 54 29	LG	100L	45	28U	20	612	13	9.6
100	87	09	04	12	56	47	13 16 36	LG	90L	40	39U	26	93	9	8.8
101	87	09	04	16	13	04	16 50 43	LG	-195R	70	33U	27	343	18	9.3
102	87	09	07	15	44	57	15 48 44	LG	-205R	80	51	62	37	3	9.7
103	87	09	14	13	12	21	13 48 42	LG	110L	55	31U	21	604	9	10.5
104	87	09	14	16	44	00	17 19 38	LG	-170R	45	30U	22	156	7	10.0
105	87	09	17	12	48	40	13 07 47	LG	100L	45	43U	32	370	9	10.5
106	87	09	17	16	02	39	16 45 36	LG	-185R	55	21U	24	841	19	10.1
107	87	09	20	12	16	09	12 40 12	LG	90L	40	39U	20	138	9	8.7
108	87	09	20	15	29	36	16 06 50	LG	-190R	65	25U	36	395	18	10.7
109	87	09	22	12	59	15	13 21 34	LG	110L	55	45U	35	352	12	10.7
110	87	09	22	16	19	04	16 53 07	LG	-170R	45	21	33	35	5	7.2
111	87	10	01	14	35	17	15 19 29	LG	-200R	80	26U	22	540	7	10.5
112	87	10	04	14	10	10	14 37 41	LG	-210R	90	49U	41	467	9	11.5
113	87	10	09	14	18	44	14 33 58	LG	-200R	80	34	75	60	15	11.0
114	87	10	12	10	25	11	10 51 23	LG	70L	33	25U	20	61	7	9.3
115	87	10	12	13	40	55	14 23 25	LG	-210R	90	25U	27	408	7	9.0
116	87	10	18	12	35	46	13 14 38	LG	130L	70	29U	27	209	7	11.2
117	87	10	19	04	45	29	04 54 12	LG	20L	60	49	60	39	5	9.9
118	87	10	19	11	18	26	11 54 33	LG	100L	50	27U	20	463	9	8.1
119	87	10	19	14	44	28	15 22 56	LG	-180R	55	24U	29	367	18	11.2
120	87	10	21	12	11	24	12 43 28	LG	120L	60	48U	20	364	7	9.3

SATELLITE LASER RANGING IN 1987

(8) No.	(9) STN	(10) TMP	(11) PRESS	(12) HUM	(13) IDT	(14) DTS	(15) DTL	(16) COMMENTS
		° C	mb	%	ns	µs	µs	
61	7838	6.1	1018.5	57	7.2	-0.2	-1.7	
62	7838	16.0	1010.4	85	7.3	-0.5	-1.7	
63	7838	13.7	1015.6	92	6.2	-0.1	-1.8	
64	7838	12.1	1003.0	62	7.5	-0.3	-1.9	
65	7838	11.1	1012.1	80	7.6	-0.2	-2.0	
66	7838	13.2	1008.7	73	7.7	-0.1	-2.1	
67	7838	14.7	1015.8	95	7.6	-0.3	-2.2	
68	7838	19.9	1008.8	88	7.4	-1.1	-1.9	
69	7838	17.4	1007.9	82	7.6	-0.5	-1.8	
70	7838	23.3	1007.7	67	7.6	-0.5	-1.5	
71	7838	21.4	1007.3	90	7.6	-0.4	-1.5	
72	7838	15.6	1007.3	94	7.6	-0.5	-0.8	
73	7838	19.5	1010.9	95	7.6	-0.3	-0.8	
74	7838	17.9	997.3	81	7.5	-0.6	-0.8	
75	7838	21.3	999.0	75	7.5	-0.6	-0.8	DAYTIME
76	7838	15.1	1000.2	89	7.6	-0.5	-0.8	
77	7838	20.9	1001.8	82	7.4	-0.5	-0.7	
78	7838	22.1	996.0	70	7.5	-0.6	-0.7	
79	7838	20.7	996.8	78	7.5	-0.6	-0.7	
80	7838	20.4	1000.2	95	7.5	-0.6	-0.7	
81	7838	20.7	1001.7	89	7.5	-0.3	-0.5	
82	7838	23.4	1003.2	91	7.5	-0.4	-0.5	
83	7838	25.9	1008.6	93	7.4	-0.4	0.2	
84	7838	25.5	1006.9	76	7.5	-0.8	0.4	
85	7838	25.3	1004.0	97	7.3	-0.5	0.4	
86	7838	23.4	1001.0	99	7.5	-0.3	0.5	
87	7838	25.3	1010.4	93	7.1	-0.8	0.6	
88	7838	23.8	1008.2	96	7.2	-0.5	0.6	
89	7838	25.5	1003.8	96	7.1	-0.3	0.6	
90	7838	29.4	1001.8	79	7.3	-0.1	0.6	DAYTIME
91	7838	25.7	1003.2	90	7.1	-0.3	0.6	
92	7838	24.0	1004.2	99	7.1	-0.4	0.6	
93	7838	25.5	1000.5	88	7.1	-0.6	0.6	
94	7838	26.0	1002.3	89	7.1	-0.3	0.6	
95	7838	24.9	1000.8	99	7.2	-0.6	0.7	
96	7838	24.3	1001.0	81	7.0	-0.7	0.7	
97	7838	26.6	1001.8	89	6.7	-0.6	0.8	
98	7838	25.5	999.7	92	6.8	-0.5	0.9	
99	7838	23.0	1003.2	72	7.4	-0.4	1.0	
100	7838	19.9	1004.9	94	7.2	-0.9	1.0	
101	7838	19.2	1003.8	93	7.2	-0.9	1.0	
102	7838	23.2	1001.2	92	7.3	-0.5	1.1	
103	7838	23.8	1000.3	79	7.2	-0.6	1.5	
104	7838	24.1	999.0	79	7.4	-0.7	1.5	
105	7838	22.9	994.6	69	9.9	-0.3	1.5	
106	7838	21.7	994.4	72	7.6	-0.5	1.5	
107	7838	22.8	1013.5	80	0.0	-0.5	1.5	
108	7838	22.6	1013.6	76	7.8	-0.7	1.5	
109	7838	19.7	1011.7	86	7.4	-0.3	1.6	
110	7838	18.8	1011.6	78	7.5	-0.4	1.6	
111	7838	17.8	1003.6	86	6.6	-1.0	1.1	
112	7838	16.7	1014.9	81	7.5	-0.4	1.0	
113	7838	22.5	1014.1	80	7.3	-0.4	0.9	
114	7838	20.6	1005.8	64	7.4	-0.6	1.0	
115	7838	19.3	1007.3	68	7.4	-0.8	1.0	
116	7838	17.8	1002.9	80	7.6	-0.7	0.9	
117	7838	25.4	999.2	51	7.7	-0.8	0.9	DAYTIME
118	7838	14.6	1005.4	80	7.5	-0.7	0.9	
119	7838	12.8	1006.0	85	7.6	-0.6	0.9	
120	7838	15.2	1010.4	57	7.6	-0.7	0.8	

(1) No.	(2) Obs. Time(UTC)						(3) SAT.	(4)Az. ST	(5)Elev.			(6) RTN	(7)Fitting				
	date			caught					lost	MX	CT		LT	N	RMS		
	Y	M	D	h	m	s	h	m	s						cm		
121	87	10	22	10	50	45	11	19	56	LG	90L	40	32U	20	320	7	10.2
122	87	10	22	14	08	01	14	18	17	LG	-190R	65	21	46	35	5	6.2
123	87	10	23	13	05	30	13	23	25	LG	140L	80	76U	41	265	7	10.5
124	87	10	28	03	03	04	03	11	25	LG	25L	85	56	83	48	7	11.5
125	87	10	28	13	11	15	13	43	39	LG	-210R	85	52U	26	322	9	10.8
126	87	11	05	09	27	42	09	49	34	LG	70L	33	28U	23	86	7	9.3
127	87	11	06	11	21	00	11	42	58	LG	120L	65	24	63	74	9	11.9
128	87	11	09	10	50	36	11	10	06	LG	110L	55	28U	54	165	9	11.5
129	87	11	09	14	25	07	14	52	19	LG	-170R	45	31U	34	124	7	8.7
130	87	12	03	13	28	59	13	56	22	LG	-170R	45	36U	27	316	9	8.7
131	87	12	04	11	54	15	12	40	22	LG	-200R	75	23U	20	414	9	9.2
132	87	12	06	12	43	22	13	27	50	LG	-180R	55	21U	20	1025	9	9.4
133	87	12	07	01	16	22	01	48	36	LG	25L	85	36U	41	64	5	8.0
134	87	12	07	11	18	50	12	06	31	LG	-210R	85	20U	20	1351	9	9.0
135	87	12	08	10	07	52	10	43	36	LG	120L	65	40U	20	849	9	9.8
136	87	12	08	13	36	50	14	12	28	LG	-160R	35	21U	20	377	7	9.0
137	87	12	13	10	16	04	10	58	21	LG	130L	75	30U	20	895	19	9.0
138	87	12	14	02	29	10	02	48	45	LG	20L	60	55U	36	390	9	9.1
139	87	12	14	08	57	15	09	34	26	LG	100L	50	25U	21	699	9	8.6
140	87	12	14	12	23	15	13	07	57	LG	-180R	55	20U	20	1244	9	8.3
141	87	12	16	09	41	35	10	23	45	LG	120L	65	26U	20	2032	17	8.0
142	87	12	16	13	18	18	13	52	51	LG	-160R	35	23U	20	686	9	7.5
143	87	12	17	01	49	28	02	16	18	LG	20L	65	47U	37	159	9	7.3
144	87	12	17	08	25	36	09	00	24	LG	90L	45	24U	20	597	9	8.6
145	87	12	17	11	52	41	12	34	25	LG	-190R	65	31U	20	1007	9	8.4
146	87	12	18	04	05	22	04	17	24	LG	20L	35	35	27	42	7	9.5
147	87	12	18	10	30	37	11	12	36	LG	140L	85	33U	20	1019	9	7.5
148	87	12	19	02	34	12	03	06	19	LG	20L	50	34U	24	165	7	8.8
149	87	12	21	09	54	59	10	38	15	LG	130L	75	27U	20	1110	20	10.2
150	87	12	22	02	05	12	02	25	03	LG	20L	60	47U	44	136	5	8.7
151	87	12	22	08	35	32	09	14	52	LG	100L	50	22U	20	1435	9	7.9
152	87	12	22	12	03	12	12	47	46	LG	-180R	55	20U	20	1498	9	8.3
153	87	12	23	00	37	32	01	05	11	LG	25L	85	39U	51	45	7	6.1
154	87	12	23	10	44	37	11	26	03	LG	-210R	85	34U	21	210	7	8.3
155	87	12	24	02	56	20	03	07	09	LG	20L	45	43U	41	71	7	8.0
156	87	12	24	09	20	12	10	03	15	LG	120L	65	23U	21	1193	9	9.5
157	87	12	24	12	59	43	13	32	30	LG	-155R	35	25U	20	577	17	8.9
158	87	12	25	08	12	24	08	38	50	LG	90L	45	35U	23	213	7	7.7
159	87	12	25	11	33	12	12	14	26	LG	-190R	65	32U	20	778	9	8.7
160	87	12	27	12	22	52	12	57	09	LG	-170R	45	26U	26	802	9	7.8
161	87	12	28	07	44	39	07	55	48	LG	80L	38	36U	34	96	7	9.4
162	87	12	28	10	59	08	11	38	32	LG	-200R	75	34U	24	148	7	9.9



(8) No.	(9) STN	(10) TMP	(11) PRESS	(12) HUM	(13) IDT	(14) DTS	(15) DTL	(16) COMMENTS
		° C	mb	%	ns	µs	µs	
121	7838	14.3	1013.8	80	7.6	-0.6	0.8	
122	7838	13.2	1015.3	80	7.5	-0.4	0.8	
123	7838	18.8	1019.8	80	7.4	-0.3	0.8	
124	7838	22.3	1014.3	71	7.4	-0.7	0.8	DAYTIME
125	7838	14.7	1016.0	93	7.2	-0.8	0.8	
126	7838	11.8	1010.6	53	7.2	-0.5	0.6	
127	7838	9.1	1014.9	73	7.5	-0.8	0.6	
128	7838	12.8	1010.4	83	7.2	-0.6	0.6	
129	7838	9.8	1011.2	94	7.2	-0.8	0.6	
130	7838	4.5	1012.1	71	7.5	-0.4	0.7	
131	7838	2.9	1016.0	77	7.4	-0.6	0.7	
132	7838	6.1	1011.2	59	7.5	-0.5	0.7	
133	7838	10.0	1019.7	48	7.7	-0.3	0.7	DAYTIME
134	7838	4.3	1023.8	72	7.6	-0.1	0.7	
135	7838	10.8	1021.7	82	7.6	-0.3	0.7	
136	7838	8.6	1021.3	84	7.5	-0.3	0.7	
137	7838	8.6	1008.4	89	7.6	-0.5	0.2	
138	7838	13.4	1016.7	50	7.7	-0.6	0.1	DAYTIME
139	7838	9.3	1018.1	66	7.5	-0.7	0.1	
140	7838	6.5	1018.6	76	7.6	-0.5	0.1	
141	7838	8.8	1009.8	51	7.5	-0.7	-0.1	
142	7838	6.5	1010.8	57	7.5	-0.7	-0.1	
143	7838	13.0	1014.9	38	7.4	-1.0	-0.2	DAYTIME
144	7838	9.5	1017.1	58	7.5	-0.9	-0.2	
145	7838	7.2	1018.9	65	7.5	-0.8	-0.2	
146	7838	12.3	1019.3	63	7.6	-0.4	-0.2	DAYTIME
147	7838	6.0	1020.2	87	7.5	-0.3	-0.2	
148	7838	14.9	1016.2	69	7.5	-0.2	-0.2	DAYTIME
149	7838	8.9	1013.2	47	7.6	-0.5	-0.2	
150	7838	14.1	1015.2	53	7.5	-0.5	-0.2	DAYTIME
151	7838	9.5	1013.8	64	7.6	-0.5	-0.2	
152	7838	8.1	1014.3	70	7.5	-0.5	-0.2	
153	7838	12.3	1017.5	50	7.6	-0.6	-0.2	DAYTIME
154	7838	8.1	1017.3	46	7.4	-0.5	-0.2	
155	7838	15.7	1019.4	32	7.6	-0.4	-0.2	DAYTIME
156	7838	10.5	1019.3	43	7.5	-0.5	-0.2	
157	7838	7.4	1019.3	43	7.3	-0.5	-0.2	
158	7838	15.2	1014.7	65	7.6	-0.5	-0.2	
159	7838	15.4	1014.7	76	7.4	-0.7	-0.2	
160	7838	12.5	1010.4	47	7.6	-0.6	-0.2	
161	7838	15.8	1007.5	80	7.5	-0.7	-0.2	DAYTIME
162	7838	11.5	1008.4	56	7.6	-0.6	-0.2	

(1) No.	(2) Obs.Time(UTC)						(3) SAT.	(4)Az. ST	(5)Elev.			(6) RTN	(7)Fitting				
	date			caught					lost				N	RMS			
	Y	M	D	h	m	s	h	m	s	MX	CT	LT				cm	
1	87	01	05	23	36	37	23	43	17	ST	-55L	65	28U	37	56	10	11.7
2	87	01	06	14	45	57	14	50	00	ST	200L	50	24U	44	272	13	8.3
3	87	01	08	15	24	32	15	31	57	ST	-110R	55	23U	20	872	19	10.0
4	87	01	09	13	55	19	14	01	08	ST	200L	55	25U	29	94	15	11.6
5	87	01	13	13	23	43	13	31	16	ST	-125R	75	23U	20	464	14	19.1
6	87	01	20	10	18	17	10	20	07	ST	200L	45	36	20	43	8	7.1
7	87	01	21	10	35	15	10	38	51	ST	225L	85	69U	30	73	11	8.4
8	87	01	26	08	32	11	08	38	13	ST	210L	60	25U	28	37	14	9.4
9	87	01	30	15	27	21	15	28	39	ST	-55L	70	38	25	39	6	9.8
10	87	02	05	06	20	57	06	26	47	ST	-105R	55	37U	20	183	17	11.7
11	87	02	05	13	40	40	13	46	33	ST	-65L	50	26U	28	345	18	11.8
12	87	02	08	12	50	05	12	56	26	ST	-65L	45	24U	22	453	18	10.9
13	87	02	09	04	02	50	04	05	45	ST	215L	65	63	30	205	11	10.2
14	87	02	10	04	19	32	04	26	04	ST	-125R	75	35U	23	304	17	14.2
15	87	02	10	11	39	39	11	46	35	ST	-55L	75	24U	24	553	18	19.5
16	87	02	14	02	02	31	02	04	58	ST	200L	45	44	27	118	10	9.8
17	87	02	16	10	00	14	10	04	19	ST	-60L	60	42U	32	334	18	10.1
18	87	02	25	00	07	14	00	10	46	ST	-105R	50	41U	39	93	11	11.6
19	87	03	24	13	14	06	13	17	04	ST	190L	40	38	21	109	8	9.9
20	87	03	26	13	46	54	13	55	04	ST	-120R	70	22U	34	223	17	9.5
21	87	03	31	11	47	45	11	54	53	ST	225L	80	39U	26	140	16	9.1
22	87	04	03	10	57	56	11	03	19	ST	-130R	85	52U	32	94	15	8.2
23	87	04	08	08	55	23	09	01	27	ST	215L	70	28U	38	252	17	9.3
24	87	04	10	07	45	25	07	51	24	ST	190L	45	23U	30	195	13	8.3
25	87	04	13	06	55	17	07	00	37	ST	195L	45	28U	32	31	7	10.9
26	87	04	20	12	56	23	13	00	01	ST	-50L	80	54U	54	101	10	8.5
27	87	04	23	12	03	22	12	11	19	ST	-55L	75	28U	29	270	9	15.2
28	87	04	24	10	33	30	10	40	41	ST	-35R	50	24U	30	206	15	9.0
29	87	05	27	23	47	44	23	50	23	ST	-35R	55	28	52	49	14	12.1
30	87	06	05	13	55	27	14	00	04	ST	220L	70	43U	39	588	13	8.8
31	87	06	07	12	44	39	12	51	13	ST	200L	45	30U	23	226	17	10.6
32	87	06	21	15	32	10	15	39	50	ST	-35R	50	21U	20	415	18	10.2
33	87	06	23	08	55	09	08	58	09	ST	-115R	65	47	20	210	9	8.1
34	87	06	26	08	03	06	08	06	09	ST	-110R	60	57	29	100	8	10.1
35	87	06	26	15	20	55	15	27	54	ST	-65L	50	25U	22	375	18	9.0
36	87	07	09	10	28	43	10	33	54	ST	-50R	90	34U	50	88	13	8.0
37	87	07	10	09	01	48	09	06	09	ST	-35R	45	41	20	144	10	8.2
38	87	07	24	04	26	53	04	33	07	ST	-35R	40	38U	20	87	11	9.8
39	87	07	27	05	29	30	05	31	47	ST	-65L	50	38	21	73	7	7.8
40	87	08	11	23	45	39	23	46	54	ST	-50L	75	48	34	28	5	11.3
41	87	08	14	15	28	43	15	30	08	ST	-120R	70	36	59	39	8	10.7
42	87	08	16	14	17	17	14	24	54	ST	220L	75	22U	21	449	14	15.4
43	87	08	17	14	37	06	14	44	11	ST	-115R	60	24U	22	360	18	10.9
44	87	08	20	13	47	04	13	51	36	ST	-110R	55	28U	39	32	5	14.3
45	87	08	21	12	17	36	12	22	18	ST	205L	50	27U	36	156	12	11.5
46	87	08	27	10	35	59	10	40	09	ST	215L	70	26U	55	113	12	9.5
47	87	08	28	10	55	31	11	02	02	ST	-120R	65	27U	23	375	18	14.6
48	87	09	01	10	25	05	10	30	40	ST	-90R	35	24U	21	278	17	11.1
49	87	09	04	15	05	23	15	12	29	ST	-40R	55	25U	21	446	18	10.2
50	87	09	07	06	55	00	07	00	40	ST	210L	60	36U	23	345	18	9.3
51	87	09	07	14	14	30	14	19	13	ST	-40R	60	23U	50	116	16	12.2
52	87	09	14	12	53	32	12	58	59	ST	-60L	60	30U	30	115	16	10.8
53	87	09	17	04	41	12	04	48	39	ST	-110R	55	24U	21	277	9	14.7
54	87	09	18	05	02	46	05	07	55	ST	-90R	35	30U	20	176	16	9.3
55	87	09	28	23	29	08	23	32	20	ST	200L	50	25	50	42	8	10.9
56	87	10	02	00	28	17	00	35	09	ST	-90R	40	25U	22	123	16	12.1
57	87	10	02	06	00	21	06	07	22	ST	-40R	55	25U	20	393	18	10.2
58	87	10	08	04	18	52	04	25	12	ST	-40R	65	26U	31	306	17	8.8
59	87	10	23	00	05	39	00	07	26	ST	-55L	75	31	53	28	7	8.5
60	87	10	28	15	02	44	15	04	23	ST	-115R	65	44	61	46	6	7.4

(8) No.	(9) STN	(10) TMP	(11) PRESS	(12) HUM	(13) IDT	(14) DTS	(15) DTL	(16) COMMENTS
		°C	mb	%	ns	µs	µs	
1	7838	7.7	1013.0	76	6.6	-0.4	-0.1	DAYTIME
2	7838	4.3	1019.9	80	7.5	-0.6	-0.2	
3	7838	5.7	1011.0	65	7.4	-0.7	-0.3	
4	7838	8.9	1010.1	57	7.4	-0.4	-0.3	
5	7838	1.7	1004.5	70	7.6	-0.2	-0.4	
6	7838	3.0	1018.6	51	7.4	-0.4	-0.7	
7	7838	4.0	1021.9	69	7.4	-0.3	-0.7	
8	7838	4.0	1018.9	53	7.0	-0.6	-0.8	
9	7838	6.5	1014.1	73	7.2	-0.6	-0.8	
10	7838	11.8	1009.2	52	7.0	-0.4	-0.8	DAYTIME
11	7838	3.9	1012.1	69	7.2	-0.3	-0.8	
12	7838	7.9	1015.6	54	6.8	-0.4	-0.8	
13	7838	16.5	1015.4	45	7.1	-0.4	-0.8	DAYTIME
14	7838	18.8	1014.3	52	7.2	-0.4	-0.8	DAYTIME
15	7838	11.7	1015.4	86	7.0	-0.4	-0.8	
16	7838	16.3	1010.8	45	6.7	-0.5	-0.9	DAYTIME
17	7838	7.5	1018.2	56	6.8	-0.9	-0.9	
18	7838	5.6	1003.8	45	6.8	-0.9	-0.8	DAYTIME
19	7838	14.6	998.8	57	7.4	-0.6	-1.1	
20	7838	3.1	1019.5	63	7.5	-0.3	-1.2	
21	7838	5.5	1012.8	57	7.4	-0.4	-1.3	
22	7838	10.3	1007.8	67	7.5	-0.5	-1.4	
23	7838	22.9	1006.4	44	7.1	-0.3	-1.4	DAYTIME
24	7838	20.9	996.9	81	7.3	-0.2	-1.5	DAYTIME
25	7838	10.6	1014.5	50	7.1	-0.2	-1.7	DAYTIME
26	7838	16.0	1015.7	88	7.2	-0.5	-1.9	
27	7838	16.7	1004.3	63	7.4	-0.2	-1.8	
28	7838	16.4	1009.8	86	7.5	-0.4	-1.7	
29	7838	20.8	1005.1	58	7.7	-0.3	-1.8	DAYTIME
30	7838	23.2	1008.2	86	7.5	-0.3	-1.5	
31	7838	22.5	1004.0	95	7.6	-0.6	-1.4	
32	7838	18.2	997.3	79	7.5	-0.7	-0.8	
33	7838	22.3	1001.2	78	7.5	-0.4	-0.7	DAYTIME
34	7838	23.6	998.4	83	7.6	-0.7	-0.7	DAYTIME
35	7838	21.5	1000.3	93	7.4	-0.4	-0.7	
36	7838	25.2	1002.3	91	7.6	-0.3	-0.5	
37	7838	27.4	1003.4	69	7.6	-0.2	-0.5	DAYTIME
38	7838	29.1	1008.7	82	7.6	-0.4	0.2	DAYTIME
39	7838	30.8	1008.6	72	7.5	-0.7	0.3	DAYTIME
40	7838	28.4	1010.6	91	7.2	-0.4	0.6	DAYTIME
41	7838	24.7	1009.0	96	6.2	-0.8	0.6	
42	7838	25.2	1004.8	99	7.3	-0.6	0.6	
43	7838	26.4	1003.8	89	7.2	-0.2	0.6	
44	7838	24.6	1001.0	95	7.4	-0.4	0.6	
45	7838	25.7	1001.8	87	7.4	-0.3	0.6	
46	7838	26.9	1000.2	82	7.4	-0.6	0.7	
47	7838	28.8	1001.6	88	7.2	-0.6	0.8	
48	7838	24.8	1001.8	69	7.4	-0.4	1.0	
49	7838	19.3	1004.0	93	7.4	-0.7	1.0	
50	7838	27.3	1000.1	76	7.3	-0.5	1.1	DAYTIME
51	7838	23.4	1001.4	93	7.4	-0.7	1.1	
52	7838	23.8	1000.5	81	7.3	-0.5	1.5	
53	7838	29.6	991.6	51	7.4	-0.2	1.5	DAYTIME
54	7838	27.5	996.2	61	7.0	-0.3	1.5	DAYTIME
55	7838	22.1	1012.8	67	7.8	-0.3	1.2	DAYTIME
56	7838	24.9	1002.1	63	7.6	-0.5	1.1	DAYTIME
57	7838	25.5	999.4	65	7.5	-0.6	1.1	DAYTIME
58	7838	25.4	1009.0	75	7.5	-0.5	0.9	DAYTIME
59	7838	19.1	1018.9	55	7.5	-0.6	0.8	DAYTIME
60	7838	14.1	1015.6	84	7.4	-0.7	0.8	

(1) No.	(2) Obs. Time(UTC)						(3) SAT.	(4)Az. ST	(5)Elev.			(6) RTN	(7)Fitting				
	date			caught					lost				N	RMS			
	Y	M	D	h	m	s	h	m	s	MX	CT	LT				cm	
61	87	11	05	12	09	39	12	17	14	ST	-120R	75	32U	26	241	17	13.1
62	87	11	06	12	28	22	12	36	39	ST	-100R	50	21U	25	200	17	8.5
63	87	11	08	11	21	52	11	26	48	ST	-120R	70	67U	23	247	13	11.2
64	87	11	09	11	38	31	11	44	37	ST	-95R	45	26U	32	97	15	9.6
65	87	12	02	10	06	45	10	08	54	ST	-40R	70	40	67	183	9	8.7
66	87	12	03	08	36	00	08	42	24	ST	-25R	33	22U	22	271	13	8.3
67	87	12	03	10	24	38	10	33	40	ST	-55L	75	25U	21	643	19	12.3
68	87	12	04	10	44	08	10	52	37	ST	-65L	45	22U	20	693	17	8.3
69	87	12	07	09	53	59	10	01	27	ST	-70L	40	24U	20	549	14	8.5
70	87	12	08	08	26	10	08	32	10	ST	-45R	80	54U	23	237	17	9.3
71	87	12	12	00	31	54	00	38	24	ST	-110R	50	21U	25	468	18	8.3
72	87	12	14	06	42	22	06	50	11	ST	-50L	80	24U	26	590	19	12.9
73	87	12	17	05	51	49	06	00	16	ST	-55L	75	24U	20	247	9	13.1
74	87	12	22	03	50	45	03	59	14	ST	-45R	80	20U	20	503	14	14.9
75	87	12	23	02	22	17	02	27	29	ST	-30R	33	22U	24	144	12	7.7
76	87	12	25	03	00	26	03	08	31	ST	-50R	85	23U	20	206	14	16.3
77	87	12	26	01	32	52	01	37	24	ST	-25R	35	30U	22	238	11	6.8

(8) No.	(9) STN	(10) TMP	(11) PRESS	(12) HUM	(13) IDT	(14) DTS	(15) DTL	(16) COMMENTS
		° C	mb	%	ns	µs	µs	
61	7838	10.3	1011.7	60	7.2	-0.6	0.6	
62	7838	8.5	1015.2	78	7.5	-0.9	0.6	
63	7838	12.4	1010.4	61	7.3	-0.4	0.6	
64	7838	12.8	1010.5	81	7.1	-0.6	0.6	
65	7838	4.5	1010.4	63	7.6	-0.3	0.6	
66	7838	7.0	1011.7	61	7.5	-0.5	0.7	
67	7838	4.2	1011.9	72	7.5	-0.6	0.7	
68	7838	4.3	1015.6	71	7.6	-0.4	0.7	
69	7838	5.2	1022.6	65	7.6	-0.2	0.7	
70	7838	11.4	1022.3	84	7.6	-0.3	0.7	
71	7838	12.8	1006.1	80	7.6	-0.4	0.3	DAYTIME
72	7838	12.6	1017.3	49	7.5	-0.6	0.1	DAYTIME
73	7838	14.2	1014.7	39	7.7	-0.9	-0.2	DAYTIME
74	7838	15.5	1013.4	48	7.6	-0.3	-0.2	DAYTIME
75	7838	14.7	1016.7	39	7.7	-0.3	-0.2	DAYTIME
76	7838	18.6	1016.5	44	7.2	-0.8	-0.2	DAYTIME
77	7838	18.6	1015.5	50	7.6	-0.8	-0.2	DAYTIME

(1) No.	(2) Obs. Time(UTC)						(3) SAT.	(4)Az. ST	(5)Elev.			(6) RTN	(7)Fitting				
	date			caught					lost	MX	CT		LT	N	RMS		
	Y	M	D	h	m	s	h	m	s					cm			
1	87	01	08	02	41	08	02	52	05	AJ	-35R	40	22U	21	744	19	10.5
2	87	01	08	04	43	52	04	55	14	AJ	-55L	80	30U	23	887	19	9.1
3	87	01	08	02	54	25	03	08	15	AJ	-40R	55	21U	25	1016	20	10.7
4	87	01	08	04	56	51	05	08	37	AJ	-65L	50	23U	20	826	19	10.6
5	87	01	09	02	01	57	02	11	05	AJ	-35R	40	27U	25	467	14	11.0
6	87	01	09	04	02	16	04	15	24	AJ	-55L	75	22U	20	1127	20	10.1
7	87	01	13	00	26	51	00	36	47	AJ	-35R	35	23U	20	494	18	9.6
8	87	01	13	02	28	05	02	37	30	AJ	-45R	85	24U	47	602	19	9.9
9	87	01	14	01	34	04	01	46	44	AJ	-40R	60	24U	20	985	19	10.7
10	87	01	14	03	36	20	03	42	48	AJ	-65L	40	22U	40	253	17	10.8
11	87	01	15	17	36	03	17	47	07	AJ	205L	55	30U	21	686	19	10.8
12	87	01	15	23	45	59	23	56	28	AJ	-35R	37	22U	21	515	9	10.8
13	87	01	16	01	47	42	01	52	53	AJ	-50L	90	24	74	282	13	11.7
14	87	01	17	00	53	19	01	06	10	AJ	-40R	65	22U	22	1007	20	9.0
15	87	01	17	02	56	10	03	05	46	AJ	-70L	37	22U	24	275	17	11.1
16	87	01	19	18	01	44	18	14	45	AJ	-110R	60	21U	21	1164	20	11.4
17	87	01	20	00	12	57	00	24	49	AJ	-45R	70	22U	29	932	19	10.8
18	87	01	20	02	16	18	02	21	31	AJ	-75L	35	22U	34	114	5	11.4
19	87	01	21	16	13	46	16	21	45	AJ	210L	70	23U	57	630	19	9.6
20	87	01	25	14	40	54	14	51	48	AJ	190L	50	27U	21	56	7	8.9
21	87	01	26	15	48	37	15	59	17	AJ	-120R	75	33U	25	184	9	10.7
22	87	01	27	00	01	15	00	08	49	AJ	-60L	37	24	37	453	18	10.4
23	87	01	27	14	53	58	14	57	47	AJ	220L	65	29	65	265	9	9.6
24	87	01	28	14	00	24	14	09	30	AJ	200L	55	27U	33	276	17	9.7
25	87	01	30	14	15	27	14	24	12	AJ	225L	85	44U	29	515	18	11.3
26	87	01	30	16	16	28	16	26	15	AJ	-80R	38	22U	24	454	14	12.5
27	87	02	01	12	30	04	12	34	11	AJ	185L	38	36	31	58	7	10.0
28	87	02	03	12	38	18	12	49	58	AJ	210L	65	22U	27	733	19	9.9
29	87	02	04	11	45	37	11	56	37	AJ	190L	40	22U	20	1009	16	10.5
30	87	02	04	13	47	04	13	59	02	AJ	-110R	60	27U	20	750	19	10.6
31	87	02	04	15	51	34	16	00	38	AJ	-60R	30	21U	20	497	18	10.2
32	87	02	05	12	51	50	13	05	07	AJ	-130R	85	23U	20	1097	20	10.0
33	87	02	05	14	56	05	15	06	22	AJ	-75R	35	21U	21	372	9	8.6
34	87	02	08	12	12	10	12	24	30	AJ	-125R	80	27U	21	189	14	10.0
35	87	02	08	14	16	10	14	25	57	AJ	-70R	35	22U	21	434	18	11.2
36	87	02	09	11	17	41	11	30	23	AJ	215L	75	23U	22	1522	20	9.5
37	87	02	09	13	20	58	13	32	09	AJ	-85R	40	22U	20	586	19	10.9
38	87	02	10	10	25	28	10	36	13	AJ	195L	50	28U	20	1030	20	10.4
39	87	02	10	12	25	33	12	38	20	AJ	-105R	55	21U	20	925	19	9.6
40	87	02	13	11	46	30	11	57	59	AJ	-100R	50	27U	20	1034	20	10.2
41	87	02	15	12	00	51	12	11	29	AJ	-85R	38	23U	20	618	19	10.0
42	87	02	16	09	03	04	09	15	47	AJ	205L	60	22U	20	507	14	10.9
43	87	02	20	07	30	09	07	38	37	AJ	185L	40	24U	30	196	13	9.8
44	87	02	20	13	39	55	13	49	42	AJ	-35R	32	21U	20	510	18	9.6
45	87	02	20	15	42	31	15	54	46	AJ	-45R	70	28U	20	790	14	9.8
46	87	02	22	13	53	57	14	04	24	AJ	-35R	40	23U	23	210	17	10.5
47	87	02	23	08	50	52	09	02	50	AJ	-110R	55	25U	20	522	14	9.6
48	87	02	23	15	01	41	15	12	29	AJ	-45R	75	25U	32	1009	18	8.8
49	87	02	25	09	06	27	09	16	19	AJ	-85R	40	28U	20	220	17	10.4
50	87	02	26	06	09	31	06	20	06	AJ	200L	50	27U	22	117	16	9.3
51	87	02	26	08	11	42	08	22	18	AJ	-105R	55	31U	21	385	18	9.5
52	87	02	26	12	19	35	12	29	25	AJ	-35R	35	22U	21	413	9	9.0
53	87	03	05	12	10	46	12	18	55	AJ	-45R	65	58U	22	585	15	9.9
54	87	03	08	11	26	50	11	38	48	AJ	-45R	70	29U	21	1364	20	8.6
55	87	03	11	08	44	11	08	53	55	AJ	-35R	33	22U	20	158	7	9.8
56	87	03	11	10	45	12	10	57	45	AJ	-45R	75	21U	20	1238	14	10.3
57	87	03	12	05	47	10	05	52	02	AJ	-75R	33	30U	29	70	5	7.8
58	87	03	16	02	06	31	02	18	27	AJ	220L	80	28U	22	125	9	11.9
59	87	03	16	04	09	38	04	18	57	AJ	-85R	40	23U	26	514	14	9.6
60	87	03	18	02	19	39	02	29	44	AJ	-120R	70	23U	38	945	19	9.9

(8) No.	(9) STN	(10) TMP	(11) PRESS	(12) HUM	(13) IDT	(14) DTS	(15) DTL	(16) COMMENTS
		C	mb	%	ns	µs	µs	
1	7838	11.8	1013.1	59	7.4	-0.4	-0.2	DAYTIME
2	7838	13.7	1012.9	50	7.5	-0.3	-0.2	DAYTIME
3	7838	13.3	1008.2	45	7.4	-0.3	-0.3	DAYTIME
4	7838	14.0	1008.2	46	7.5	-0.2	-0.3	DAYTIME
5	7838	13.4	1009.7	49	7.7	-0.3	-0.3	DAYTIME
6	7838	14.1	1008.0	43	7.5	-0.4	-0.3	DAYTIME
7	7838	3.4	995.5	81	7.4	-0.4	-0.4	DAYTIME
8	7838	4.2	995.3	55	7.5	-0.2	-0.4	DAYTIME
9	7838	6.0	1013.0	48	7.6	-0.5	-0.5	DAYTIME
10	7838	7.1	1011.4	40	7.5	-0.6	-0.5	DAYTIME
11	7838	4.3	1021.0	72	7.6	-0.5	-0.5	
12	7838	6.9	1022.1	68	7.5	-0.6	-0.5	DAYTIME
13	7838	12.8	1022.3	58	7.5	-0.5	-0.6	DAYTIME
14	7838	15.6	1017.3	64	7.4	-0.6	-0.6	DAYTIME
15	7838	16.5	1005.5	47	7.4	-0.5	-0.6	DAYTIME
16	7838	1.3	1012.3	67	7.5	-0.5	-0.7	
17	7838	5.7	1016.9	50	7.5	-0.6	-0.7	DAYTIME
18	7838	6.5	1016.0	40	7.6	-0.4	-0.7	DAYTIME
19	7838	2.9	1023.0	63	7.6	-0.3	-0.7	
20	7838	-0.6	1015.2	64	7.3	-0.7	-0.8	
21	7838	0.5	1019.1	75	7.3	-0.7	-0.8	
22	7838	6.6	1019.7	54	7.4	-0.2	-0.8	DAYTIME
23	7838	6.3	1016.7	71	7.0	-0.2	-0.8	
24	7838	5.2	1020.2	59	7.1	-0.3	-0.8	
25	7838	5.8	1014.5	79	6.9	-0.7	-0.8	
26	7838	6.6	1014.1	70	7.3	-0.6	-0.8	
27	7838	2.9	1020.2	66	7.1	-0.6	-0.8	
28	7838	3.6	996.6	67	7.1	-0.1	-0.8	
29	7838	2.1	1009.0	55	7.2	-0.4	-0.8	
30	7838	1.6	1009.7	62	6.8	-0.1	-0.8	
31	7838	0.8	1009.9	74	7.4	-0.3	-0.8	
32	7838	3.1	1011.9	75	7.2	-0.3	-0.8	
33	7838	3.9	1012.5	68	7.3	-0.2	-0.8	
34	7838	8.0	1015.2	55	7.0	-0.3	-0.8	
35	7838	7.7	1016.0	54	7.1	-0.4	-0.8	
36	7838	8.6	1017.1	73	7.1	-0.3	-0.8	
37	7838	8.3	1017.3	72	7.2	-0.5	-0.8	
38	7838	13.2	1015.2	80	7.0	-0.5	-0.8	
39	7838	11.0	1015.4	89	7.1	-0.5	-0.8	
40	7838	8.1	1012.1	92	6.9	-0.4	-0.9	
41	7838	4.4	1015.6	72	7.1	-0.8	-0.9	
42	7838	9.0	1017.5	46	6.8	-0.9	-0.9	
43	7838	11.1	1014.5	67	6.4	-0.7	-0.9	DAYTIME
44	7838	5.2	1017.8	55	6.8	-0.6	-0.9	
45	7838	3.5	1018.0	59	7.0	-0.6	-0.9	
46	7838	4.0	1010.4	99	7.1	-1.1	-0.9	
47	7838	11.0	1009.5	44	6.5	-0.8	-0.9	
48	7838	5.6	1011.7	65	6.6	-0.8	-0.9	
49	7838	2.8	1007.2	47	6.8	-0.9	-0.8	
50	7838	5.7	1006.2	37	6.4	-1.0	-0.8	DAYTIME
51	7838	4.4	1006.0	40	6.8	-0.9	-0.8	DAYTIME
52	7838	2.4	1007.7	47	6.8	-1.1	-0.8	
53	7838	10.6	1008.0	67	6.3	-0.6	-0.8	
54	7838	6.4	1011.0	85	6.3	-0.8	-0.8	
55	7838	9.1	1004.2	60	7.6	-0.4	-0.8	DAYTIME
56	7838	7.7	1006.6	62	7.8	-0.4	-0.8	
57	7838	13.6	1013.1	64	7.5	-0.2	-0.9	DAYTIME
58	7838	12.5	1010.1	45	6.6	-0.4	-0.9	DAYTIME
59	7838	12.9	1009.3	50	7.5	-0.4	-0.9	DAYTIME
60	7838	17.0	1007.3	45	7.5	-0.4	-1.0	DAYTIME



(1) No.	(2) Obs. Time(UTC)						(3) SAT.	(4)Az. ST	(5)Elev.			(6) RTN	(7)Fitting				
	date			caught					lost	MX	CT		LT	N	RMS		
	Y	M	D	h	m	s	h	m	s						cm		
61	87	03	18	08	30	36	08	42	54	AJ	-40R	65	21U	24	520	18	9.8
62	87	03	18	10	34	03	10	44	05	AJ	-70L	40	25U	20	379	18	11.0
63	87	03	20	06	43	07	06	53	46	AJ	-35R	37	22U	20	582	19	9.7
64	87	03	20	08	44	45	08	57	04	AJ	-50L	85	24U	24	733	9	10.3
65	87	03	24	05	11	07	05	14	28	AJ	-40R	32	29U	31	65	7	9.4
66	87	03	25	00	04	39	00	17	38	AJ	-125R	80	23U	21	921	9	10.4
67	87	03	25	06	17	25	06	26	48	AJ	-40R	55	29U	30	595	19	9.6
68	87	03	26	05	22	24	05	33	32	AJ	-35R	40	22U	20	825	19	9.1
69	87	03	26	07	23	31	07	36	52	AJ	-55L	75	21U	20	1094	9	10.0
70	87	03	27	00	18	44	00	31	06	AJ	-105R	55	22U	22	682	19	9.1
71	87	03	27	04	28	57	04	37	57	AJ	-35R	33	23U	20	243	7	8.5
72	87	03	27	06	30	37	06	38	24	AJ	-45R	80	28U	55	543	18	9.3
73	87	03	31	00	49	01	00	57	15	AJ	-65R	32	21U	24	141	7	8.2
74	87	03	31	04	55	38	05	05	39	AJ	-40R	80	24U	35	502	18	10.7
75	87	04	03	23	14	56	23	23	10	AJ	-80R	37	27U	24	234	13	9.9
76	87	04	04	03	21	06	03	33	11	AJ	-40R	50	22U	20	523	18	9.6
77	87	04	10	02	01	13	02	05	10	AJ	-40R	55	26	51	86	9	9.1
78	87	04	10	04	06	13	04	07	08	AJ	-60L	50	43	47	30	5	9.2
79	87	04	13	01	20	42	01	28	01	AJ	-40R	60	26U	50	327	18	10.4
80	87	04	13	03	22	04	03	33	06	AJ	-65L	45	21U	23	234	17	9.9
81	87	04	14	02	28	12	02	33	59	AJ	-55L	70	25	69	105	12	10.6
82	87	04	16	00	42	41	00	47	29	AJ	-40R	60	42U	54	85	11	9.1
83	87	04	16	02	42	22	02	52	52	AJ	-70L	40	23U	21	66	15	9.1
84	87	04	20	01	09	26	01	18	34	AJ	-60L	60	36U	26	345	14	9.7
85	87	04	20	16	01	21	16	12	47	AJ	205L	60	30U	20	426	18	10.7
86	87	04	21	00	18	39	00	19	19	AJ	-50L	85	78	84	37	3	9.4
87	87	04	23	15	20	02	15	30	06	AJ	210L	65	25U	35	373	18	10.4
88	87	04	23	23	32	30	23	40	56	AJ	-50L	80	22U	60	521	14	8.9
89	87	04	24	16	27	55	16	37	51	AJ	-110R	60	24U	34	586	19	9.8
90	87	04	26	22	53	28	23	05	00	AJ	-55L	70	29U	22	187	9	10.2
91	87	04	29	14	07	27	14	12	00	AJ	220L	80	55	20	225	9	9.3
92	87	05	01	14	20	25	14	22	22	AJ	-120R	65	61	42	86	7	8.8
93	87	05	03	12	25	50	12	37	23	AJ	205L	60	28U	20	1103	20	8.9
94	87	05	03	14	26	49	14	39	07	AJ	-100R	50	21U	20	667	19	9.0
95	87	05	04	11	32	50	11	42	31	AJ	180L	37	25U	20	574	19	9.6
96	87	05	04	13	32	02	13	45	18	AJ	-115R	65	21U	20	813	14	10.1
97	87	05	05	14	42	02	14	52	43	AJ	-80R	37	22U	20	508	18	11.0
98	87	05	06	11	47	28	11	53	40	AJ	210L	60	44U	42	478	18	10.5
99	87	05	06	13	48	49	13	58	26	AJ	-95R	45	32U	32	562	12	8.5
100	87	05	07	12	52	12	13	04	53	AJ	-110R	60	24U	20	909	12	9.7
101	87	05	08	11	58	55	12	10	40	AJ	-130R	85	31U	22	803	19	8.8
102	87	05	10	10	14	54	10	20	05	AJ	190L	45	43U	31	74	11	9.6
103	87	05	19	08	10	33	08	21	30	AJ	205L	60	32U	20	792	19	8.9
104	87	05	19	10	11	10	10	22	59	AJ	-100R	50	22U	22	309	17	9.7
105	87	05	24	13	53	12	14	05	56	AJ	-40R	50	21U	20	1094	20	10.5
106	87	05	28	08	07	17	06	12	02	AJ	215L	75	21	60	181	13	9.9
107	87	05	28	08	20	48	08	22	21	AJ	-85R	40	26	20	28	5	6.0
108	87	05	28	12	19	04	12	30	46	AJ	-35R	40	22U	20	1091	20	9.6
109	87	05	28	14	20	31	14	33	56	AJ	-55L	70	21U	20	1271	14	9.7
110	87	05	31	11	39	36	11	47	33	AJ	-35R	45	26U	35	539	12	8.9
111	87	05	31	13	40	22	13	53	21	AJ	-55L	65	22U	20	806	19	10.6
112	87	06	01	04	37	35	04	42	28	AJ	200L	55	47U	41	184	11	9.4
113	87	06	01	06	44	53	06	47	41	AJ	-100R	50	37	21	40	5	10.8
114	87	06	01	10	45	09	10	55	08	AJ	-35R	35	23U	21	659	9	8.7
115	87	06	04	10	04	10	10	15	17	AJ	-35R	37	20U	20	527	14	10.4
116	87	06	04	12	05	47	12	18	59	AJ	-50L	85	22U	22	970	9	12.0
117	87	06	05	03	05	18	03	09	57	AJ	185L	38	38	25	44	5	9.3
118	87	06	05	11	18	31	11	24	35	AJ	-45R	70	67	22	172	10	8.5
119	87	06	05	13	17	17	13	23	36	AJ	-75L	35	32U	26	243	13	10.6
120	87	06	10	08	51	39	08	55	08	AJ	-35R	40	35	20	65	9	9.6

(8) No.	(9) STN	(10) TMP	(11) PRESS	(12) HUM	(13) IDT	(14) DTS	(15) DTL	(16) COMMENTS
		° C	mb	%	ns	µs	µs	
61	7838	14.2	1008.8	64	7.4	-0.4	-1.0	DAYTIME
62	7838	11.5	1010.6	80	7.6	-0.4	-1.0	
63	7838	17.8	1003.6	66	7.5	-0.3	-1.0	DAYTIME
64	7838	15.3	1006.0	71	7.1	-0.4	-1.0	DAYTIME
65	7838	21.7	990.4	75	7.3	-0.3	-1.1	DAYTIME
66	7838	15.4	1000.9	55	7.5	-0.7	-1.2	DAYTIME
67	7838	15.4	1001.8	33	7.4	-0.8	-1.2	DAYTIME
68	7838	11.5	1013.0	46	7.5	-0.3	-1.2	DAYTIME
69	7838	11.6	1013.4	45	7.5	0.0	-1.2	DAYTIME
70	7838	10.3	1020.8	45	7.6	-0.3	-1.2	DAYTIME
71	7838	12.1	1019.7	48	7.5	-0.3	-1.2	DAYTIME
72	7838	12.6	1017.8	51	7.6	-0.2	-1.2	DAYTIME
73	7838	17.1	1006.4	53	6.5	-0.7	-1.3	DAYTIME
74	7838	17.0	1004.9	40	7.4	-0.6	-1.3	DAYTIME
75	7838	12.8	1012.5	60	7.4	-0.8	-1.4	DAYTIME
76	7838	19.4	1011.4	38	7.5	-0.8	-1.4	DAYTIME
77	7838	20.9	999.1	83	7.3	-0.5	-1.5	DAYTIME
78	7838	22.8	997.7	72	7.3	-0.2	-1.5	DAYTIME
79	7838	10.7	1015.9	45	7.2	-0.3	-1.7	DAYTIME
80	7838	10.9	1015.8	43	7.3	-0.3	-1.7	DAYTIME
81	7838	11.5	1019.7	51	7.3	-0.4	-1.7	DAYTIME
82	7838	16.0	1019.1	68	7.3	-0.3	-1.8	DAYTIME
83	7838	16.9	1018.6	69	7.3	-0.3	-1.8	DAYTIME
84	7838	21.2	1017.0	48	7.3	0.2	-1.9	DAYTIME
85	7838	15.2	1015.1	96	7.4	-0.5	-1.9	
86	7838	19.9	1014.2	80	7.1	-0.5	-1.9	DAYTIME
87	7838	13.8	1004.7	73	7.4	-0.4	-1.8	
88	7838	20.8	1007.9	43	7.4	-0.4	-1.8	DAYTIME
89	7838	10.6	1012.2	86	7.6	-0.4	-1.7	
90	7838	13.1	1011.7	59	7.3	-0.6	-1.7	DAYTIME
91	7838	12.5	1015.9	92	7.5	-0.1	-1.8	
92	7838	18.8	1002.8	91	7.4	-0.6	-1.9	
93	7838	13.3	1002.4	57	7.5	-0.3	-1.9	
94	7838	11.9	1004.0	58	7.6	-0.6	-1.9	
95	7838	11.5	1011.9	78	7.6	-0.2	-2.0	
96	7838	10.4	1012.8	77	7.7	-0.3	-2.0	
97	7838	11.8	1010.0	68	7.6	-0.3	-2.0	
98	7838	14.0	1008.6	69	7.6	-0.2	-2.1	
99	7838	12.3	1008.4	78	7.7	-0.2	-2.1	
100	7838	13.3	1010.1	91	7.5	-0.4	-2.1	
101	7838	15.4	1016.2	94	7.7	-0.4	-2.2	
102	7838	16.9	1018.9	90	7.6	-0.2	-2.2	
103	7838	20.4	1014.5	85	7.5	-0.5	-2.1	DAYTIME
104	7838	18.4	1015.2	92	7.5	-0.6	-2.1	
105	7838	19.2	1009.1	86	7.6	-0.9	-1.9	
106	7838	21.1	1006.0	60	7.6	-0.2	-1.8	DAYTIME
107	7838	20.4	1006.4	67	7.5	-0.5	-1.8	DAYTIME
108	7838	15.5	1009.7	91	7.7	-0.5	-1.8	
109	7838	14.2	1010.8	95	7.4	-0.4	-1.8	
110	7838	18.1	1012.3	96	6.5	-0.4	-1.6	
111	7838	16.7	1013.0	96	7.4	-0.2	-1.6	
112	7838	23.1	1014.7	79	7.5	-0.2	-1.6	DAYTIME
113	7838	22.3	1014.1	79	7.5	-0.1	-1.6	DAYTIME
114	7838	19.8	1014.6	89	7.5	-0.4	-1.6	
115	7838	24.1	1006.4	71	7.5	-0.5	-1.5	
116	7838	22.3	1007.9	76	7.6	-0.5	-1.5	
117	7838	26.0	1008.2	79	7.6	-0.2	-1.5	DAYTIME
118	7838	24.8	1007.5	82	7.8	-0.3	-1.5	
119	7838	22.6	1008.0	90	7.6	-0.1	-1.5	
120	7838	22.5	1003.1	74	7.6	-0.6	-1.2	DAYTIME

(1) No.	(2) Obs. Time(UTC)		(3) SAT.	(4)Az. ST	(5)Elev.			(6) RTN	(7)Fitting	
	date	caught			lost	MX	CT		LT	N
	Y M D	h m s	h m s							cm
121	87 06 12	02 47 54	02 51 54	AJ	-125R	80	37 78	113	8	10.6
122	87 06 17	02 25 51	02 28 33	AJ	-100R	55	51 40	62	7	9.2
123	87 06 17	08 38 13	08 39 35	AJ	-35R	35	32 20	160	10	9.0
124	87 06 18	07 38 36	07 42 01	AJ	-45L	65	35 62	85	9	9.2
125	87 06 21	23 50 52	23 57 00	AJ	130R	90	24 88	664	19	9.0
126	87 06 22	01 55 19	02 05 13	AJ	-75R	35	24U 20	746	15	9.0
127	87 06 22	06 02 27	06 14 25	AJ	-40R	50	23U 21	395	18	8.7
128	87 06 22	08 08 57	08 16 43	AJ	-60L	55	52U 20	296	17	10.9
129	87 06 25	01 14 56	01 24 59	AJ	-75R	35	22U 20	361	7	10.5
130	87 06 25	05 21 27	05 31 04	AJ	-40R	55	20U 39	85	9	11.6
131	87 06 25	07 29 30	07 35 57	AJ	-65L	55	51U 20	618	13	10.0
132	87 06 26	00 19 16	00 30 01	AJ	-90R	45	21U 24	594	19	10.3
133	87 06 26	04 30 50	04 38 14	AJ	-35R	40	35U 25	423	18	9.6
134	87 06 26	06 36 28	06 42 38	AJ	-55L	75	73 20	458	10	8.7
135	87 06 26	23 25 44	23 34 21	AJ	-110R	55	29U 36	328	14	9.9
136	87 07 04	03 22 18	03 33 42	AJ	-40R	65	32U 20	1009	20	9.4
137	87 07 08	01 46 10	01 58 32	AJ	-40R	50	21U 21	528	18	9.7
138	87 07 08	18 41 02	18 53 31	AJ	210L	65	22U 22	1005	20	8.9
139	87 07 15	01 43 37	01 45 39	AJ	-55L	70	38 24	48	6	7.9
140	87 07 24	14 25 48	14 37 49	AJ	210L	65	25U 22	1246	20	9.9
141	87 07 24	16 27 58	16 39 51	AJ	-90R	45	21U 20	1153	18	8.7
142	87 07 26	14 40 25	14 51 57	AJ	-125R	80	33U 20	1546	20	7.7
143	87 07 28	12 55 02	12 58 59	AJ	195L	50	41U 43	153	8	10.2
144	87 07 28	14 58 02	15 04 24	AJ	-105R	55	53U 26	433	12	9.9
145	87 07 29	13 59 18	14 11 42	AJ	-125R	75	27U 20	1480	20	9.3
146	87 07 29	16 03 09	16 11 40	AJ	-70R	33	21U 25	862	7	7.1
147	87 08 03	11 30 21	11 42 30	AJ	205L	55	21U 22	1577	18	8.3
148	87 08 03	13 35 18	13 40 26	AJ	-95R	50	36U 44	533	10	8.4
149	87 08 06	12 52 53	13 04 10	AJ	-95R	45	24U 21	526	15	8.9
150	87 08 11	12 28 09	12 37 32	AJ	-75R	35	23U 20	578	13	8.7
151	87 08 12	09 29 10	09 42 14	AJ	215L	70	23U 20	1181	14	9.5
152	87 08 12	11 32 12	11 40 52	AJ	-90R	40	21U 33	719	13	8.6
153	87 08 12	15 43 45	15 49 36	AJ	-40R	40	36U 31	701	11	10.0
154	87 08 14	15 53 48	15 59 34	AJ	-40R	60	21 57	365	10	8.7
155	87 08 16	16 07 31	16 21 00	AJ	-50R	85	21U 20	1583	16	10.2
156	87 08 17	07 02 46	07 11 35	AJ	180L	35	22U 23	769	14	8.7
157	87 08 17	09 02 05	09 15 28	AJ	-120R	70	21U 20	1422	20	9.5
158	87 08 17	15 13 32	15 25 22	AJ	-40R	60	21U 27	1598	20	9.1
159	87 08 18	08 10 42	08 18 33	AJ	225L	80	39U 40	465	18	9.7
160	87 08 19	07 15 13	07 27 14	AJ	205L	60	25U 20	1139	20	8.8
161	87 08 19	09 16 38	09 28 57	AJ	-100R	50	21U 20	747	19	9.2
162	87 08 20	08 26 01	08 34 50	AJ	-115R	65	50U 22	502	18	9.5
163	87 08 20	14 34 16	14 46 15	AJ	-45R	65	27U 21	854	19	9.3
164	87 08 21	07 28 56	07 37 54	AJ	225L	90	29U 43	465	18	9.0
165	87 08 21	09 32 07	09 42 41	AJ	-75R	35	22U 20	328	18	10.3
166	87 08 21	13 40 13	13 51 41	AJ	-40R	50	26U 20	877	19	10.4
167	87 08 23	13 53 02	14 06 07	AJ	-45R	70	22U 20	663	14	10.4
168	87 08 24	13 04 26	13 10 00	AJ	-40R	55	51U 28	348	10	8.6
169	87 08 24	15 01 56	15 13 10	AJ	-60L	55	27U 21	744	19	9.4
170	87 08 25	14 15 02	14 19 30	AJ	-50L	80	59 22	414	10	9.5
171	87 08 26	05 01 26	05 07 04	AJ	195L	45	26U 44	270	13	10.4
172	87 08 26	07 08 50	07 11 36	AJ	-105R	60	55 36	127	5	10.2
173	87 08 26	13 12 57	13 25 42	AJ	-45R	75	24U 21	833	14	10.4
174	87 08 27	08 13 17	08 21 33	AJ	-70R	33	27U 21	452	7	8.6
175	87 08 28	05 18 12	05 26 28	AJ	215L	75	64U 20	870	15	8.6
176	87 08 28	07 20 01	07 28 00	AJ	-90R	40	37U 20	549	18	10.1
177	87 08 28	11 28 47	11 33 39	AJ	-35R	40	39U 32	299	9	10.3
178	87 08 28	13 26 24	13 36 06	AJ	-55L	70	22U 43	786	19	9.4
179	87 09 01	03 46 51	03 51 31	AJ	200L	55	49 21	182	9	9.3
180	87 09 01	05 42 51	05 50 38	AJ	-100R	50	30U 37	277	7	9.8

(8) No.	(9) STN	(10) TMP	(11) PRESS	(12) HUM	(13) IDT	(14) DTS	(15) DTL	(16) COMMENTS
		° C	mb	%	ns	µs	µs	
121	7838	22.7	1009.5	66	7.6	-0.5	-1.1	DAYTIME
122	7838	23.4	1009.9	75	7.5	-0.5	-0.8	DAYTIME
123	7838	23.7	1009.7	75	7.5	-0.4	-0.8	DAYTIME
124	7838	23.3	1012.3	81	7.5	-0.4	-0.8	DAYTIME
125	7838	22.2	998.8	66	7.5	-0.5	-0.8	DAYTIME
126	7838	22.8	999.2	62	7.6	-0.4	-0.8	DAYTIME
127	7838	21.9	999.0	80	7.5	-0.5	-0.8	DAYTIME
128	7838	21.8	999.0	78	7.6	-0.5	-0.8	DAYTIME
129	7838	24.7	996.4	62	7.5	-0.4	-0.7	DAYTIME
130	7838	26.0	995.3	48	7.6	-0.5	-0.7	DAYTIME
131	7838	25.2	994.6	50	7.4	-0.7	-0.7	DAYTIME
132	7838	24.5	997.9	71	7.6	-0.4	-0.7	DAYTIME
133	7838	24.6	998.4	78	7.6	-0.6	-0.7	DAYTIME
134	7838	24.3	998.4	81	7.6	-0.5	-0.7	DAYTIME
135	7838	25.4	1002.1	76	7.6	-0.4	-0.7	DAYTIME
136	7838	27.6	999.4	76	7.6	-0.5	-0.7	DAYTIME
137	7838	27.2	1000.8	80	7.6	-0.2	-0.5	DAYTIME
138	7838	20.5	1001.7	86	7.6	-0.4	-0.5	
139	7838	28.6	1007.3	90	7.4	-0.6	-0.3	DAYTIME
140	7838	25.8	1009.0	96	7.4	-0.2	0.2	
141	7838	25.9	1008.6	93	7.5	-0.4	0.2	
142	7838	25.9	1010.1	80	7.5	-0.6	0.3	
143	7838	26.9	1007.5	76	7.5	-0.6	0.4	
144	7838	25.9	1007.0	73	7.4	-0.7	0.4	
145	7838	25.3	1005.3	97	7.4	-0.7	0.4	
146	7838	25.3	1004.5	98	7.4	-0.6	0.4	
147	7838	25.2	1005.3	96	7.6	-0.4	0.6	
148	7838	24.8	1005.3	98	7.6	-0.8	0.6	
149	7838	23.9	1001.0	99	7.4	-0.5	0.5	
150	7838	25.5	1010.6	94	7.1	-0.8	0.6	
151	7838	26.7	1009.0	91	7.2	-0.4	0.6	DAYTIME
152	7838	25.4	1009.5	96	7.3	-0.4	0.6	
153	7838	23.6	1008.2	98	7.3	-0.5	0.6	
154	7838	24.6	1008.8	98	6.2	-0.7	0.6	
155	7838	25.7	1004.0	97	7.2	-0.6	0.6	
156	7838	29.6	1001.8	78	7.3	-0.2	0.6	DAYTIME
157	7838	28.3	1002.5	80	7.2	-0.2	0.6	DAYTIME
158	7838	26.0	1003.6	90	7.2	-0.4	0.6	
159	7838	28.8	1002.5	82	7.5	-0.5	0.6	DAYTIME
160	7838	29.2	1003.6	90	6.9	-0.2	0.6	DAYTIME
161	7838	26.9	1003.6	91	7.0	-0.2	0.6	DAYTIME
162	7838	27.9	1000.1	84	7.5	-0.4	0.6	DAYTIME
163	7838	25.7	1001.0	86	7.4	-0.4	0.6	
164	7838	29.5	1000.1	69	7.2	-0.4	0.6	DAYTIME
165	7838	26.6	1000.5	84	7.3	-0.4	0.6	DAYTIME
166	7838	26.0	1002.1	86	7.4	-0.3	0.6	
167	7838	25.6	1000.5	98	7.2	-0.7	0.7	
168	7838	24.6	1000.1	97	7.0	-0.4	0.7	
169	7838	24.0	999.7	99	7.2	-0.4	0.7	
170	7838	26.9	999.0	82	7.1	-0.7	0.7	
171	7838	34.1	998.6	52	7.3	-0.5	0.7	DAYTIME
172	7838	33.3	998.4	54	7.3	-0.4	0.7	DAYTIME
173	7838	24.7	1000.5	81	7.2	-0.5	0.7	
174	7838	28.9	998.8	80	7.4	-0.5	0.7	DAYTIME
175	7838	30.8	999.4	62	7.0	-0.6	0.8	DAYTIME
176	7838	30.3	999.7	69	7.1	-0.7	0.8	DAYTIME
177	7838	26.7	1001.8	87	6.9	-0.6	0.8	
178	7838	26.6	1001.8	91	6.6	-0.6	0.8	
179	7838	28.7	1000.8	54	7.3	-0.5	1.0	DAYTIME
180	7838	29.4	999.9	53	7.2	-0.4	1.0	DAYTIME

(1) No.	(2) Obs. Time (UTC)				(3) SAT.	(4) Az. ST	(5) Elev.			(6) RTN	(7) Fitting		
	date			lost			MX	CT	LT		N	RMS	
	Y	M	D	h m s	h m s						cm		
181	87	09	01	11 51 59	12 04 45	AJ	-50R	85	23U	23	1417	20	9.3
182	87	09	03	04 00 43	04 05 25	AJ	225L	85	63	22	339	14	9.5
183	87	09	04	11 13 07	11 24 30	AJ	-50L	90	32U	22	1350	20	8.6
184	87	09	07	02 26 37	02 30 58	AJ	210L	65	52	21	170	16	9.6
185	87	09	07	04 20 56	04 32 28	AJ	-95R	45	22U	22	819	19	9.5
186	87	09	08	09 36 58	09 49 27	AJ	-45R	70	21U	25	616	14	10.1
187	87	09	09	02 31 35	02 45 11	AJ	-130R	85	22U	20	1750	18	9.3
188	87	09	09	04 38 49	04 41 23	AJ	-75R	35	31U	35	201	7	9.4
189	87	09	10	09 54 15	10 00 09	AJ	-50L	75	47U	49	33	8	8.4
190	87	09	11	02 48 59	02 57 56	AJ	-105R	55	41U	24	891	15	8.6
191	87	09	16	23 27 46	23 29 04	AJ	200L	55	48	54	49	5	7.4
192	87	09	17	01 25 49	01 37 47	AJ	-100R	50	23U	21	707	19	8.9
193	87	09	17	05 35 04	05 45 07	AJ	-35R	35	23U	20	439	18	9.0
194	87	09	17	09 45 43	09 46 49	AJ	-90L	25	22	20	112	8	11.1
195	87	09	18	00 30 33	00 43 52	AJ	-120R	70	21U	21	1662	20	9.0
196	87	09	18	02 36 08	02 45 12	AJ	-65R	30	22U	21	593	9	7.9
197	87	09	18	04 41 35	04 49 41	AJ	-40R	30	24U	20	187	11	8.6
198	87	09	18	23 36 50	23 49 58	AJ	225L	85	24U	20	863	16	10.6
199	87	09	19	01 40 30	01 51 31	AJ	-80R	38	21U	20	737	19	9.9
200	87	09	21	06 03 55	06 09 01	AJ	-45R	65	35	65	488	10	10.9
201	87	10	02	02 12 42	02 24 43	AJ	-35R	45	21U	20	879	19	10.8
202	87	10	02	04 14 38	04 27 17	AJ	-55L	65	23U	21	451	18	10.9
203	87	10	03	01 19 10	01 29 17	AJ	-35R	35	22U	21	449	18	9.4
204	87	10	03	03 20 09	03 32 52	AJ	-50R	85	21U	25	945	19	10.2
205	87	10	05	01 33 33	01 43 51	AJ	-40R	45	27U	23	356	18	9.2
206	87	10	07	01 46 43	01 52 21	AJ	-45R	70	26	68	314	11	8.9
207	87	10	08	00 53 18	00 56 04	AJ	-40R	50	28	44	63	7	9.3
208	87	10	08	02 54 53	02 59 02	AJ	-60L	55	27	53	78	7	10.2
209	87	10	09	00 01 54	00 06 05	AJ	-20R	40	36U	34	123	10	9.7
210	87	10	12	16 15 09	16 23 30	AJ	195L	45	33U	27	338	14	8.3
211	87	10	18	14 58 13	15 04 20	AJ	200L	60	56	20	56	14	11.2
212	87	10	18	16 57 02	17 03 45	AJ	-100R	50	39U	33	265	13	9.3
213	87	10	19	14 00 33	14 08 08	AJ	180L	35	27U	22	92	7	11.4
214	87	10	19	15 59 42	16 12 21	AJ	-115R	65	25U	20	242	17	10.7
215	87	10	20	00 15 07	00 22 40	AJ	-70L	38	30U	26	118	7	7.7
216	87	10	20	23 20 09	23 28 36	AJ	-55L	60	32U	35	552	18	9.4
217	87	10	21	14 12 31	14 23 26	AJ	205L	60	29U	24	835	14	8.9
218	87	10	21	16 14 23	16 15 52	AJ	-95R	45	25	33	16	3	6.0
219	87	10	22	13 20 06	13 29 30	AJ	185L	40	29U	20	203	5	11.1
220	87	10	22	23 38 04	23 40 24	AJ	-75L	35	35	31	21	7	11.0
221	87	10	28	11 58 49	12 08 52	AJ	195L	50	30U	21	477	18	10.5
222	87	10	28	13 58 31	14 11 14	AJ	-110R	55	22U	20	569	19	10.1
223	87	10	29	13 04 19	13 15 25	AJ	-125R	75	24U	31	583	17	8.4
224	87	11	05	10 49 25	11 01 59	AJ	225L	85	24U	23	614	14	10.1
225	87	11	06	09 55 54	10 08 24	AJ	205L	60	24U	20	893	14	10.1
226	87	11	06	11 58 18	12 10 06	AJ	-95R	45	23U	20	596	19	11.4
227	87	11	08	10 08 49	10 22 09	AJ	-130R	85	22U	21	590	14	10.9
228	87	11	08	12 13 23	12 20 35	AJ	-75R	35	22U	31	84	7	10.4
229	87	11	09	09 15 02	09 28 05	AJ	210L	65	22U	20	956	14	10.2
230	87	11	09	11 17 51	11 29 19	AJ	-90R	45	22U	22	397	18	10.6
231	87	11	09	15 26 34	15 37 45	AJ	-40R	40	22U	20	130	16	10.7
232	87	12	02	08 56 20	09 04 43	AJ	-35R	35	22U	27	166	12	9.5
233	87	12	02	10 57 51	11 06 05	AJ	-50R	85	24U	59	566	13	8.2
234	87	12	03	05 57 11	06 06 18	AJ	-65R	32	21U	21	686	9	7.1
235	87	12	03	08 01 52	08 10 28	AJ	-35R	30	21U	22	879	7	7.2
236	87	12	03	10 03 19	10 16 35	AJ	-45R	60	21U	20	1293	20	9.8
237	87	12	03	12 06 30	12 17 06	AJ	-70L	40	24U	20	1118	20	9.4
238	87	12	04	09 09 35	09 21 22	AJ	-35R	45	22U	21	1533	20	10.4
239	87	12	04	11 11 03	11 24 16	AJ	-55L	60	21U	20	1543	20	8.5
240	87	12	06	11 26 40	11 36 21	AJ	-70L	37	25U	20	1092	14	8.7

(8) No.	(9) STN	(10) TMP	(11) PRESS	(12) HUM	(13) IDT	(14) DTS	(15) DTL	(16) COMMENTS
		' C	mb	%	ns	µs	µs	
181	7838	24.3	1002.9	69	7.3	-0.5	1.0	
182	7838	26.2	1007.1	73	7.3	-0.4	1.0	DAYTIME
183	7838	21.1	1004.9	89	6.6	-0.8	1.0	
184	7838	28.1	1000.1	76	7.3	-0.4	1.1	DAYTIME
185	7838	28.6	999.7	74	7.2	-0.4	1.1	DAYTIME
186	7838	26.2	1003.2	88	7.3	-0.7	1.2	
187	7838	28.7	1005.6	81	7.4	-0.4	1.2	DAYTIME
188	7838	28.7	1005.1	82	7.2	-0.5	1.2	DAYTIME
189	7838	26.6	1006.0	91	7.2	-0.7	1.3	
190	7838	29.2	1005.1	78	7.4	-0.4	1.3	DAYTIME
191	7838	27.1	992.0	59	7.7	-0.3	1.5	DAYTIME
192	7838	28.1	992.5	63	7.4	-0.3	1.5	DAYTIME
193	7838	29.5	991.4	53	7.4	-0.3	1.5	DAYTIME
194	7838	24.2	993.0	65	9.8	-0.1	1.5	
195	7838	27.3	997.0	56	7.5	-0.4	1.5	DAYTIME
196	7838	28.1	996.8	58	7.7	-0.4	1.5	DAYTIME
197	7838	27.4	996.2	61	6.8	-0.3	1.5	DAYTIME
198	7838	24.2	1003.2	51	6.8	-0.3	1.5	DAYTIME
199	7838	25.6	1003.2	51	6.7	-0.4	1.5	DAYTIME
200	7838	24.8	1014.1	73	7.8	-0.6	1.6	DAYTIME
201	7838	25.8	1001.4	65	7.4	-0.4	1.1	DAYTIME
202	7838	25.8	1000.3	66	7.5	-0.4	1.1	DAYTIME
203	7838	25.5	1002.7	48	7.6	-0.5	1.0	DAYTIME
204	7838	26.5	1001.8	49	7.6	-0.5	1.0	DAYTIME
205	7838	24.6	1017.3	69	7.5	-0.3	1.0	DAYTIME
206	7838	24.6	1009.4	75	6.5	-0.4	0.9	DAYTIME
207	7838	25.6	1010.4	58	7.5	-0.4	0.9	DAYTIME
208	7838	25.7	1009.8	73	7.5	-0.3	0.9	DAYTIME
209	7838	23.7	1013.3	65	7.4	-0.4	0.9	DAYTIME
210	7838	19.9	1008.2	65	7.6	-0.7	1.0	
211	7838	17.3	1002.3	85	7.6	-0.8	0.9	
212	7838	17.9	1001.3	89	7.7	-0.9	0.9	
213	7838	13.1	1006.0	86	7.6	-0.8	0.9	
214	7838	12.8	1006.2	83	7.6	-0.8	0.9	
215	7838	20.4	1006.9	49	7.7	-0.5	0.9	DAYTIME
216	7838	17.5	1009.7	49	7.7	-0.7	0.9	DAYTIME
217	7838	14.3	1010.6	61	7.6	-0.7	0.8	
218	7838	13.6	1010.8	61	7.4	-0.7	0.8	
219	7838	13.2	1015.2	80	7.5	-0.5	0.8	
220	7838	19.3	1018.6	53	7.6	-0.6	0.8	DAYTIME
221	7838	15.6	1015.8	94	7.2	-0.9	0.8	
222	7838	14.3	1015.9	92	7.3	-0.7	0.8	
223	7838	18.1	1014.4	90	7.3	-0.5	0.8	
224	7838	10.7	1011.0	57	7.2	-0.8	0.6	
225	7838	9.2	1014.5	76	7.4	-0.5	0.6	
226	7838	8.9	1015.2	75	7.5	-0.8	0.6	
227	7838	12.8	1010.4	62	7.1	-0.7	0.6	
228	7838	11.9	1010.6	63	7.4	-0.5	0.6	
229	7838	14.0	1009.9	77	7.3	-0.6	0.6	
230	7838	12.9	1010.4	81	7.2	-0.7	0.6	
231	7838	10.5	1011.2	91	7.1	-0.6	0.6	
232	7838	4.7	1009.7	64	7.4	-0.4	0.6	
233	7838	4.5	1010.4	63	7.5	-0.2	0.6	
234	7838	10.3	1010.8	42	7.7	-0.4	0.7	DAYTIME
235	7838	7.9	1011.7	51	7.6	-0.6	0.7	
236	7838	5.6	1011.9	63	7.6	-0.5	0.7	
237	7838	4.5	1012.1	72	7.6	-0.6	0.7	
238	7838	5.6	1015.4	64	7.6	-0.4	0.7	
239	7838	3.9	1015.7	72	7.4	-0.5	0.7	
240	7838	6.4	1009.9	62	7.5	-0.2	0.7	

(1) No.	(2) Obs. Time(UTC)						(3) SAT.	(4)Az. ST	(5)Elev.			(6) RTN	(7)Fitting				
	date			caught		lost			MX	CT	LT		N	RMS			
	Y	M	D	h	m	s	h	m	s					cm			
241	87	12	07	02	18	09	02	31	01	AJ	225L	90	25U	20	761	14	10.0
242	87	12	07	04	21	42	04	32	22	AJ	-75R	35	21U	20	811	7	7.8
243	87	12	07	08	29	04	08	41	34	AJ	-40R	50	21U	20	1603	18	8.9
244	87	12	07	10	30	57	10	43	44	AJ	-60L	55	21U	20	1592	20	10.6
245	87	12	08	07	35	22	07	46	22	AJ	-35R	38	22U	20	551	9	8.9
246	87	12	08	09	37	28	09	48	37	AJ	-50L	80	26U	29	1149	20	10.0
247	87	12	12	01	51	32	02	04	17	AJ	-110R	55	22U	20	1454	20	8.7
248	87	12	13	09	10	27	09	22	33	AJ	-65L	50	21U	20	1014	18	8.8
249	87	12	14	00	03	59	00	16	15	AJ	215L	75	28U	20	1463	20	8.6
250	87	12	14	02	07	11	02	17	45	AJ	-90R	40	26U	20	1083	16	8.4
251	87	12	14	06	14	25	06	26	13	AJ	-40R	40	21U	20	1233	16	8.8
252	87	12	14	08	16	26	08	28	58	AJ	-55L	70	24U	22	1523	20	8.9
253	87	12	15	09	28	57	09	33	50	AJ	-80L	27	27U	20	118	7	7.2
254	87	12	16	08	30	16	08	42	00	AJ	-65L	45	21U	20	651	9	9.5
255	87	12	16	23	23	07	23	35	54	AJ	220L	80	25U	20	557	14	7.8
256	87	12	17	01	26	01	01	37	12	AJ	-85R	40	21U	20	604	9	7.6
257	87	12	17	05	33	57	05	46	05	AJ	-40R	45	21U	20	994	17	7.9
258	87	12	17	07	35	39	07	48	57	AJ	-55L	65	21U	20	1291	20	9.4
259	87	12	18	00	30	55	00	43	27	AJ	-100R	50	21U	20	1005	18	8.4
260	87	12	18	04	41	29	04	50	47	AJ	-35R	35	26U	20	1044	9	7.5
261	87	12	18	06	41	24	06	55	05	AJ	-50R	85	21U	20	1578	14	8.8
262	87	12	18	23	36	11	23	49	28	AJ	-120R	70	21U	20	910	14	10.0
263	87	12	19	01	41	17	01	50	56	AJ	-65R	30	20U	20	726	13	7.1
264	87	12	20	23	50	40	23	59	32	AJ	-95R	50	21U	38	533	14	8.2
265	87	12	21	03	59	53	04	10	42	AJ	-35R	37	21U	20	439	14	8.5
266	87	12	21	06	01	29	06	14	44	AJ	-50L	85	23U	20	1101	14	9.7
267	87	12	22	01	01	17	01	10	41	AJ	-65R	30	21U	20	450	12	6.8
268	87	12	22	03	05	36	03	15	12	AJ	-35R	30	20U	20	573	13	7.3
269	87	12	23	00	05	47	00	16	33	AJ	-75R	35	20U	20	517	14	8.5
270	87	12	23	04	13	06	04	24	28	AJ	-40R	50	20U	26	893	15	8.7
271	87	12	24	03	24	12	03	30	33	AJ	-40R	38	38U	20	271	13	9.8
272	87	12	24	05	21	00	05	34	21	AJ	-50L	80	22U	20	1327	14	8.6
273	87	12	25	02	25	44	02	35	03	AJ	-40R	32	22U	20	461	7	8.2
274	87	12	25	04	26	41	04	40	17	AJ	-45R	70	21U	20	928	14	9.7
275	87	12	25	23	25	56	23	36	10	AJ	-75R	35	21U	20	711	7	8.5
276	87	12	28	01	45	03	01	55	01	AJ	-35R	33	21U	20	486	12	8.1
277	87	12	28	03	46	20	03	59	47	AJ	-45R	75	21U	21	1560	9	9.8



(8) No.	(9) STN	(10) TMP	(11) PRESS	(12) HUM	(13) IDT	(14) DTS	(15) DTL	(16) COMMENTS
241	7838	9.9	1019.5	47	7.6	-0.4	0.7	DAYTIME
242	7838	10.9	1019.5	51	7.2	-0.4	0.7	DAYTIME
243	7838	6.5	1022.1	59	7.6	-0.2	0.7	
244	7838	4.9	1023.2	69	7.6	-0.1	0.7	
245	7838	11.6	1022.6	83	7.5	-0.3	0.7	DAYTIME
246	7838	11.2	1021.9	80	7.7	-0.3	0.7	
247	7838	15.4	1005.5	90	7.6	-0.4	0.3	DAYTIME
248	7838	9.0	1007.7	90	7.5	-0.2	0.2	
249	7838	9.6	1017.1	86	7.5	-0.5	0.1	DAYTIME
250	7838	13.2	1016.7	49	7.7	-0.5	0.1	DAYTIME
251	7838	13.1	1016.9	48	7.6	-0.5	0.1	DAYTIME
252	7838	11.4	1017.8	57	7.4	-0.5	0.1	
253	7838	9.6	1011.0	85	7.4	-0.6	0.0	
254	7838	9.6	1008.6	50	7.3	-0.6	-0.1	
255	7838	8.6	1014.7	52	7.7	-0.8	-0.1	DAYTIME
256	7838	12.5	1015.6	41	7.6	-0.9	-0.2	DAYTIME
257	7838	14.8	1014.7	41	7.6	-0.9	-0.2	DAYTIME
258	7838	11.3	1016.2	50	7.4	-1.0	-0.2	DAYTIME
259	7838	10.0	1021.7	60	7.7	-0.4	-0.2	DAYTIME
260	7838	12.2	1019.3	62	7.5	-0.5	-0.2	DAYTIME
261	7838	11.6	1019.3	61	7.6	-0.3	-0.2	DAYTIME
262	7838	8.5	1018.6	63	7.4	-0.4	-0.2	DAYTIME
263	7838	14.0	1017.5	65	7.6	-0.2	-0.2	DAYTIME
264	7838	10.5	1010.4	48	7.4	-0.4	-0.2	DAYTIME
265	7838	14.0	1009.5	34	7.5	-0.6	-0.2	DAYTIME
266	7838	14.0	1010.1	36	7.6	-0.5	-0.2	DAYTIME
267	7838	12.8	1016.5	50	7.4	-0.6	-0.2	DAYTIME
268	7838	15.1	1014.1	51	7.5	-0.4	-0.2	DAYTIME
269	7838	10.8	1017.5	57	7.5	-0.4	-0.2	DAYTIME
270	7838	14.8	1015.4	39	7.7	-0.6	-0.2	DAYTIME
271	7838	15.6	1019.0	31	7.5	-0.7	-0.2	DAYTIME
272	7838	16.4	1018.0	34	7.7	-0.5	-0.2	DAYTIME
273	7838	17.8	1017.8	44	7.3	-0.6	-0.2	DAYTIME
274	7838	18.6	1014.9	44	7.2	-0.6	-0.2	DAYTIME
275	7838	12.5	1015.6	68	6.6	-0.6	-0.2	DAYTIME
276	7838	18.8	1010.6	41	7.7	-0.5	-0.2	DAYTIME
277	7838	19.4	1008.0	42	7.6	-0.7	-0.2	DAYTIME

## COLLOCATION OBSERVATION BETWEEN TWO SLR STATIONS AT THE SIMOSATO HYDROGRAPHIC OBSERVATORY IN 1987

**Summary** — The first collocation observation between the satellite laser ranging station of the Simosato Hydrographic Observatory (called SHOLAS in this report) and the HTLRS was made at the Simosato Hydrographic Observatory in December, 1987. 3 Ajisai passes and 6 Lageos passes were observed. Analyzing these data, it is shown that the systematic difference between two stations is 1.1 cm. The range data of the SHOLAS is longer than the HTLRS. There is no significant difference between range data of Ajisai and those of Lageos. More data are needed for detailed analysis.

**Key words:** SHOLAS—HTLRS—collocation observation

### 1. Observation

The satellite laser ranging (SLR) observation has been continued at the Simosato Hydrographic Observatory (SHO) since 1982 (Sasaki *et al.*, 1983). Simosato has played an important role in SLR worldwide network because Simosato is the only one station in Asia which constantly releases SLR observation data.

A transportable laser ranging system, the HTLRS (Hydrographic Department Transportable Laser Ranging Station) was completed in 1987 (Sasaki, 1988). This station has been used for the precise determination of position of Japanese off-lying islands since 1988.

Prior to the observation at off-lying islands, the first collocation observation was made at the Simosato Hydrographic Observatory in December, 1987. The primary purpose of this observation is to detect systematic errors of both the HTLRS and the SHOLAS.

From December 13th to December 18th, 9 passes were observed and 12729 returns were obtained by two stations. Pass table is shown in Table 1. Three of these passes are Ajisai and six of them are Lageos. The sky coverage of these passes is shown in Figure 1.

### 2. Survey

In October, 1987, the reference points at the Simosato Hydrographic Observatory were surveyed by M. Nagaoka (Figure 2 and 3). The geodetic position of each point is shown in Table 2 and 3. The HTLRS was put just above the reference plate (TL) on a concrete base. The thickness of this concrete base is about 1 m (Figure 4), and this concrete base is very stable. The relative position of the intersection of the azimuth and elevation axes (called the center of rotation in this report) of the HTLRS (TL-01) to the reference plate (TL) was measured optically. We can measure the horizontal component of relative position vector between TL-01 and TL by means of reading the scale on the reference plate through the telescope equipped in the HTLRS. The position of ground markers and the reference plate was surveyed by theodolite and distancemeter. The position of the center of rotation of the SHOLAS was surveyed by T. Takemura (1983).

Table 1. Passes table of collocation observation in December 1987

No.	time		SHOLAS (return)	HTLRS (return)	Satellite
	h m	h m			
1	1987 Dec. 13	9 10 - 9 23	1018	531	Ajisai
2		13 10 16 - 10 58	909	466	Lageos
3		14 8 16 - 8 29	1546	281	Ajisai
4		14 8 57 - 9 34	771	74	Lageos
5		16 8 30 - 8 42	674	174	Ajisai
6		16 9 42 - 10 24	2061	107	Lageos
7		17 8 26 - 9 0	600	450	Lageos
8		17 11 52 - 12 34	1009	184	Lageos
9		18 10 28 - 11 13	1021	853	Lageos
total			9609	3120	
			12729		

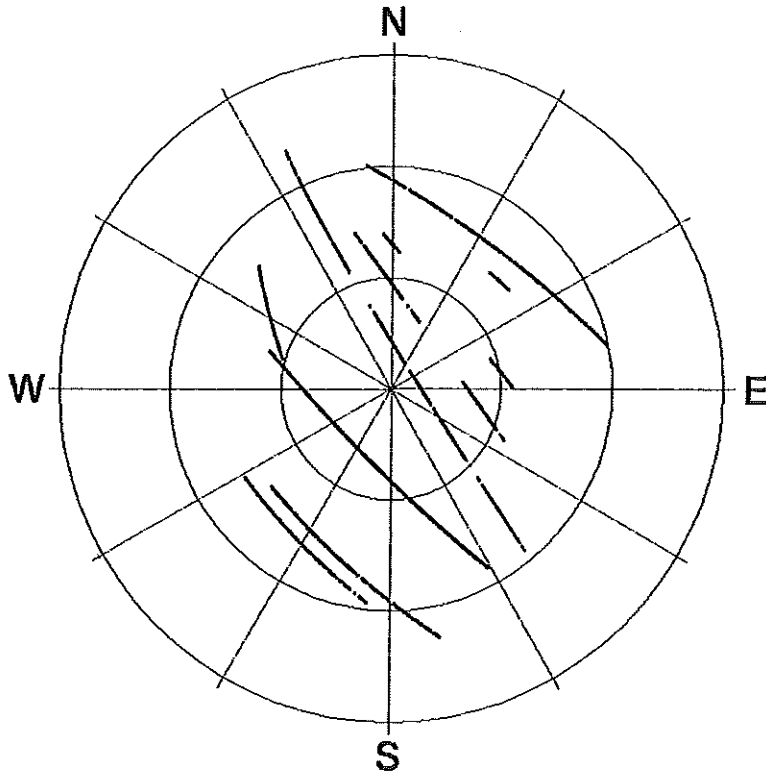

Figure 1. Sky coverage

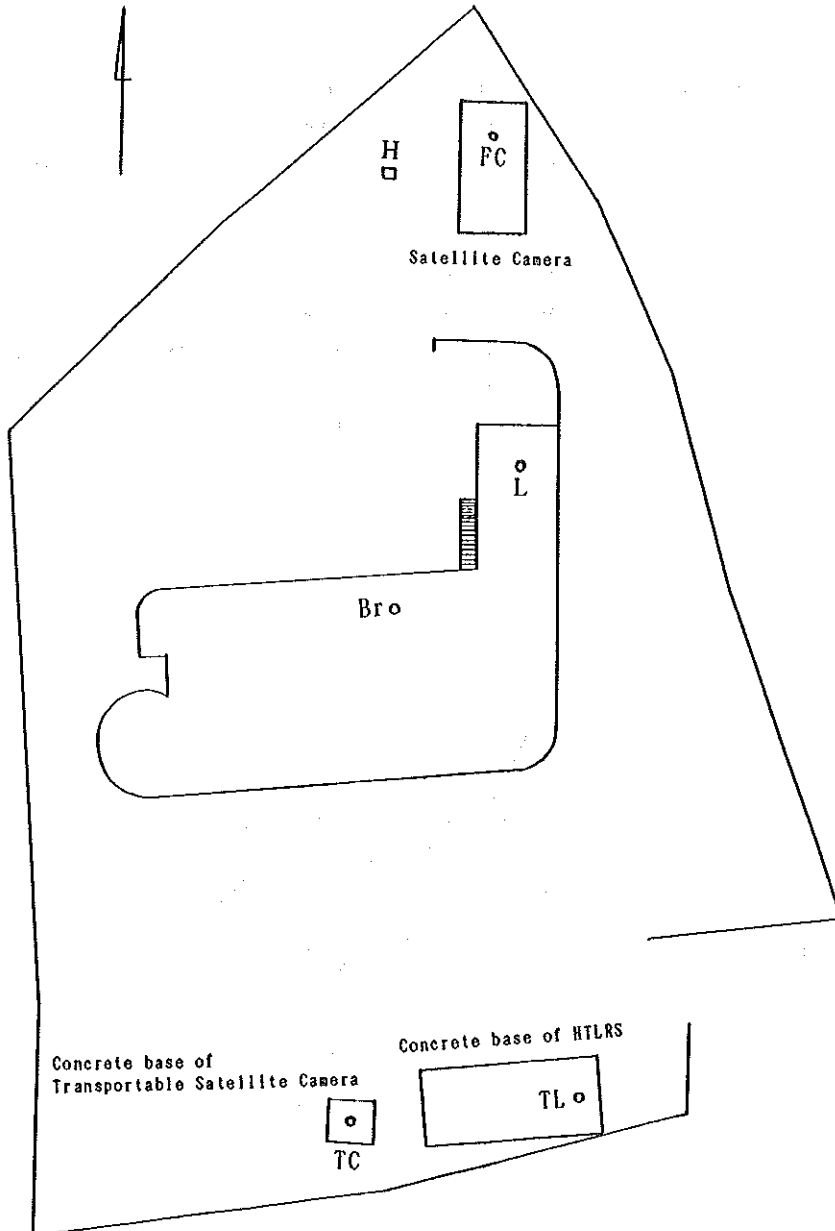

Figure 2. Simosato Hydrographic Observatory

- H : Fiducial stone marker
- Br : Surveying reference marker
- L : Satellite laser ranging system (Center of rotation)
- FC : Reference marker  
on the concrete base of Satellite Camera
- TL : Reference marker  
on the concrete base of HTLRS
- PC : Center of the reference plate  
on the concrete base of HTLRS
- MN : Northern Sub-Reference marker  
on the concrete base of HTLRS
- MS : Southern Sub-Reference marker  
on the concrete base of HTLRS
- TC : Reference marker  
on the concrete base  
of Transportable Satellite Camera

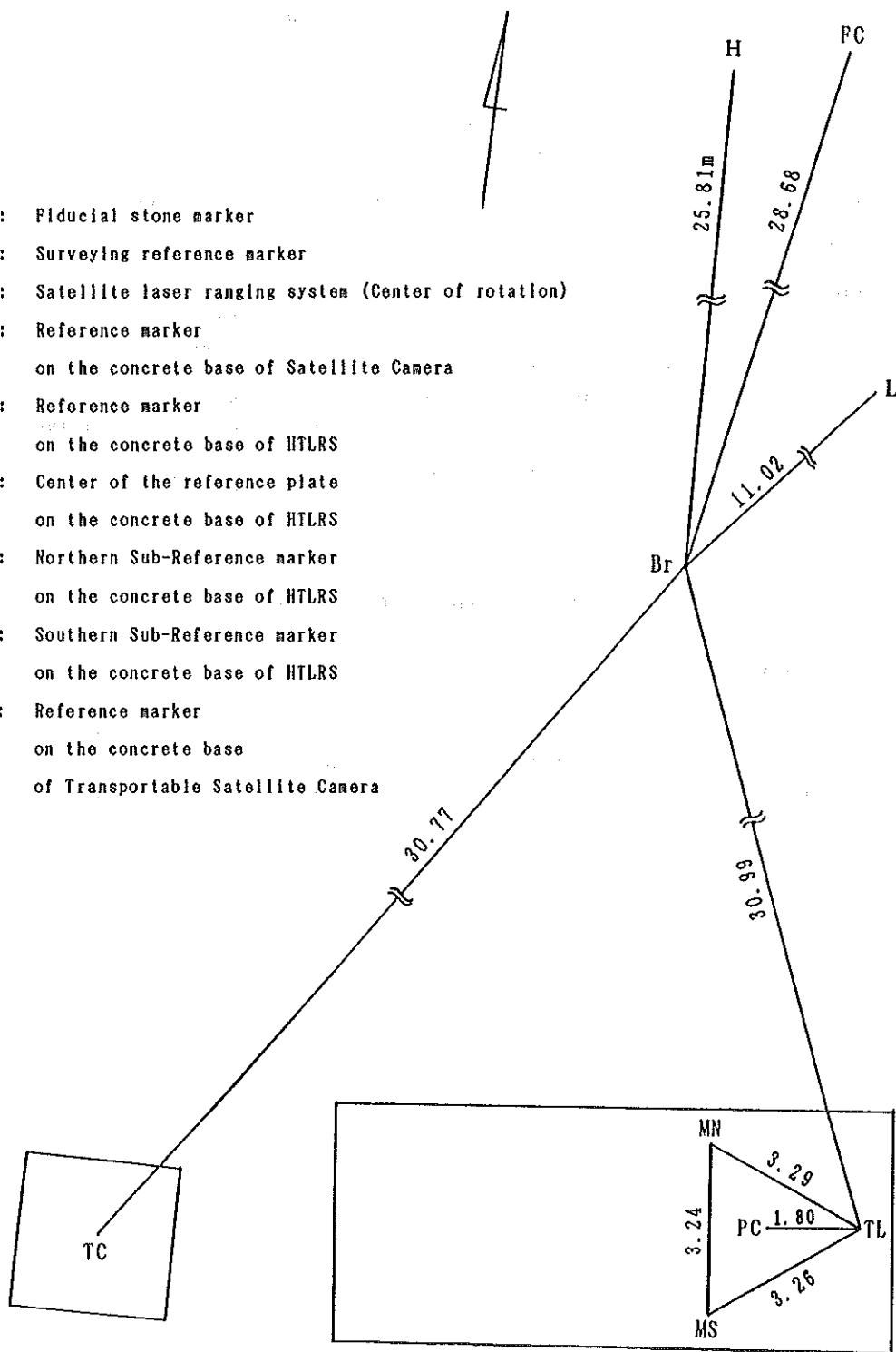

Figure 3. Survey chart

## Positions of reference points (Tokyo Datum)

Reference point	Symbol	Latitude	Longitude	Height	Note
Fiducial stone marker	H	33°34'28".078 N	135°56'23".236 E	58.36 m	
Surveying reference marker	Br	34 27.240	56 23.239	61.33	
Satellite laser ranging system	L	34 27.496	56 23.537	62.44	Center of rotation
Satellite Camera	FC	34 28.153	56 23.458	59.28	Reference marker on the concrete base
HTLRS	TL	34 26.296	56 23.655	57.59	Reference marker on the concrete base
"	PC	34 26.290	56 23.586	57.59	Center of the plate on the base
"	MN	34 26.338	56 23.537	57.59	Northern sub-marker on the base
"	MS	34 26.234	56 23.553	57.59	Southern sub-marker on the base
"	TL-01	34 26.290	56 23.586	59.52	Center of rotation of HTLRS in December, 1987
Transportable Satellite Camera	TC	34 26.249	56 23.090	57.81	Reference marker on the concrete base

## Relative positions of reference points

Symbol	Latitude	Longitude	Height
L - Br	+0".2565	+0".2978	+1.112 m
Br - TL	+0.9437	-0.4158	+3.744
Br - TL-01	+0.9505	-0.3467	+1.813

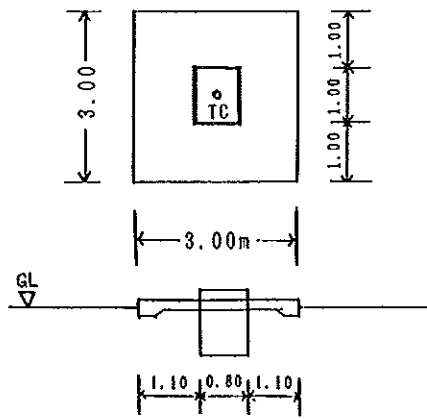
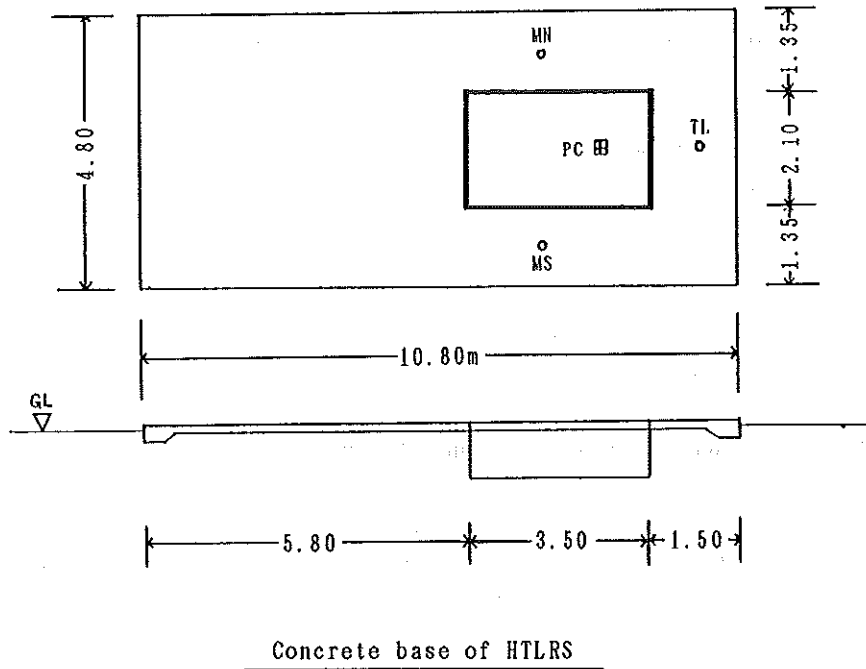

Figure 4. Concrete base of HTLRS and Transportable Satellite Camera



The relative rectangular coordinates of the center of rotation of the HTLRS to that of the SHOLAS in the equator and Greenwich based system as follows.

$$dx = -13.901 \text{ (m)}$$

$$dy = 11.697 \text{ (m)}$$

$$dz = -32.600 \text{ (m)}$$

The distance between two centers of rotation is 37.320 (m).

In the local horizontal coordinates, the relative position of the HTLRS from the SHOLAS is,

$$dX = 1.261 \text{ (m) eastward}$$

$$dY = -37.187 \text{ (m) northward}$$

$$dZ = -2.928 \text{ (m) upward}$$

### 3. Principle of Geometrical Analysis of Collocation Observation

In this chapter, we discuss on the idea of geometrical analysis of collocation observation. The goal of precision of our analysis is set to be 1 mm.

Let  $r_1$  ( $r_2$ ) be the position vector from station 1 (2) to the satellite, and let  $d$  ( $= r_1 - r_2$ ) be the relative position vector of station 2 from station 1 (Figure 5).

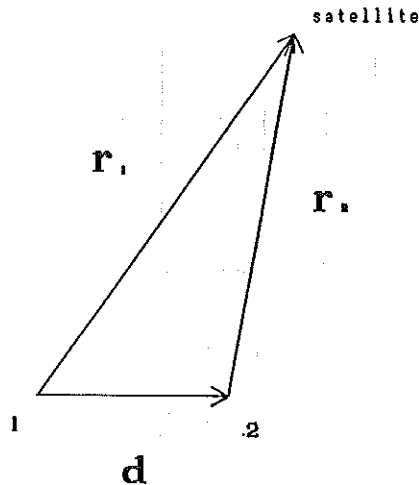

Figure 5.

In collocation observation,  $|d|/|r_{1,2}|$  is so small that geometrical range difference ( $dr$ ) can be expanded by the power series of  $|d|/|r_{1,2}|$  as follows.

$$\begin{aligned} dr &= |r_1| - |r_2| \\ &= |r_2 + d| - |r_2| \\ &= |r_2| \{ |r_2 + d|/|r_2| - 1 \} \\ &= |r_2| \{ r_2 \cdot d / |r_2|^2 + 1/2 (|d|/|r_2|)^2 \\ &\quad - (r_2 \cdot d / |r_2|^2)^2 + \dots \} \end{aligned} \quad (1)$$

The first term is the primary part of  $dr$ . The other terms are negligible if the two systems are close enough. In our case,  $|d| = 37.320$  (m) and  $|r_2| \gtrsim 1.5 \times 10^6$  m, the magnitude of the second order term of eccentric correction is less than 0.5 mm and negligible. Then geometrical range difference is written in a simple form.

$$dr = r_2 \cdot d / |r_2| \quad (2)$$

We call this expression the eccentric correction.

If there is no systematic error in both two stations raw range difference is equal to the eccentric correction. Difference between the eccentric correction and raw range difference,

$$\begin{aligned} D &= dr - (|r_1| - |r_2|) \\ &= r_2 \cdot d / |r_2| - (|r_1| - |r_2|) \end{aligned} \quad (3)$$

stands for systematic error of range observation data. If  $D$  is positive, range observation of station 2 is longer than that of station 1.

If range observations are made at two stations simultaneously at time  $t$ , we can easily calculate raw range difference ( $|r_1(t)| - |r_2(t)|$ ). But in practice, range data cannot be obtained simultaneously. Therefore, we have to interpolate range data in some manner. Raw range data of one station are smoothed by polynomial fitting and smoothed data points at each observation time of the other station are calculated in order to estimate equation (3).

For precise estimation of the eccentric correction, it is necessary to determine orbits of satellites through dynamical procedure. Predicted positions of satellites usually have so large error that they bring large systematic errors in collocation analysis. Measured elevation and azimuth angles which are read from the encoder of each system also have systematic errors on account of setting error of encoders and should not be used. 40 m positional error of satellites causes 1 mm error of the eccentric correction.

#### 4. Geometrical Analysis

##### 4.1 Determination of orbits

The precise orbits of satellites are determined dynamically by the reduction program of Hydrographic Department (Sasaki, 1984) using the range data obtained by the SHOLAS and the HTLRS. SLR observation data of two passes are used to determine the orbits. GEM-T1 (36th order) is used for the Earth's gravity model. Polar motion determined by IRIS is used. (BIH circular D) Since the orbits are determined by only the SHOLAS and the HTLRS which are placed only 40 m apart, the determined orbits are accurate quite locally. But it is sufficient for our analysis. Our goal of the accuracy of satellite position is 40 m around Japan. It is possible to achieve 40 m accuracy by local analysis. Table 4 shows the obtained residuals for each pass. Noise level of raw range data obtained by the SHOLAS and the HTLRS is about 9 cm and 5 cm, respectively. Therefore, residuals are expected to be 5 ~ 9 cm. In most cases, residuals are within this range. The residuals for Dec. 14th and 16th (Ajisai) are larger than 10 cm, and there may be some systematic errors in determination of orbits.

Then, the topocentric position of satellites are calculated with enough accuracy at each observation time.

Table 4. Dynamical determination of the orbits

No.	used pass No.	Satellite of data	Number	residual
a	1, 3	Ajisai	3376	7.5 cm
b	2, 4	Lageos	2220	10.5
c	3, 5	Ajisai	2675	7.8
d	6, 7	Lageos	3218	8.2
e	7, 8*	Lageos	2234	7.7
f	8, 9	Lageos	3048	6.5

\* successive passes

##### 4.2 Estimation of D

Next, smoothed data points of the SHOLAS at observation time of the HTLRS are estimated by polynomial fitting. Smoothing process is stable because the range data of the SHOLAS was obtained in large quantities. The orders of polynomials which are shown for each pass in Table 5 gives the smallest r.m.s. of D. We show a sample of (order of polynomial) - (D) relation in Figure 6. While the order is small, the mean of D approaches to 0 and r.m.s. of D becomes smaller as the order becomes larger. There is an extreme value of r.m.s. of D, however, at a certain order. When the order is larger than this order, r.m.s. becomes slightly larger than the extreme value.

Then,  $D$  is estimated by equation (3). Table 5 shows the data used for the estimation of  $D$  and Table 6 shows the results. Noisy data whose residuals are larger than 15 cm are omitted.

The average of the mean of  $D$  ( $\bar{D}$ ) is  $-1.08$  cm. Roughly speaking, this means that range data obtained by the SHOLAS is 1.08 cm longer than those obtained by the HTLRS. We cannot conclude whichever the SHOLAS or the HTLRS causes this difference. We only have detected a small systematic difference between two stations. This systematic difference may cause systematic error of position of Simosato or Japanese off-lying islands in a few mm level.

The average of the mean of  $D$  is  $-0.23$  cm for Ajisai and  $-1.57$  cm for Lageos. This difference is not meaningful since obtained data of Ajisai is not sufficient. It is more reasonable to consider that there is not significant difference between range data of Ajisai and those of Lageos.

In Figures 7 and 8, we show the time dependance of  $D$ . There is no remarkable time dependance of  $D$ .

$D$  vs. elevation and  $D$  vs. azimuth are plotted in Figure 9 and 10. There is neither notable elevation dependance nor notable azimuth dependance in  $D$ .

More data are needed for detailed analysis. Figure 10 shows that the balance of sky coverage is not so good. More data are necessary to separate elevation dependance and azimuth dependance.

## 5. Dynamical Analysis

Systematic errors also can be detected through dynamical analysis.

The precise orbits of satellites are determined in the same way as geometrical analysis. SLR observation data of two passes are used to determine the orbits.

If the orbits of satellites are determined with sufficient accuracy and if there is no systematic error, then distribution of residuals of both two stations will be Gaussian and the mean of residuals will be zero. Figures 11 and 12 show the residuals of both two stations. If there is a constant bias in range data of either of two stations then the residuals of the SHOLAS and those of the HTLRS differ to some extent which indicate this bias. We summarize the difference of the mean of residuals in Table 7. The last column of Table 7 shows this bias. Like geometrical analysis, the range data obtained by the SHOLAS is longer than those obtained by the HTLRS. The average of this bias is  $-0.96$  cm ( $-0.16$  cm for Ajisai and  $-1.35$  cm for Lageos).

The means of residuals of both two stations (see fourth and fifth columns of Table 7) tend to be negative. It is because the distribution of residuals is not symmetrical (Figures 13 and 14). It is clear from the figures that the means are inclined to be negative if we omit noisy data whose residuals are larger.

The results of dynamical analysis agree well with the results of geometrical analysis. The reason why the results of two analyses differ slightly is that used data sets are not all the same.

Table 5. Geometrical analysis of collocation observation

No.	time		SHOLAS (return)	HTLRS (return)	Satellite	polynomial order
	h m	h m				
1	1987 Dec. 13	9 17 - 9 23	423	494	Ajisai	11
2		13 10 26 - 10 47	750	458	Lageos	13
3		14 8 21 - 8 29	1138	254	Ajisai	15
4		14 9 12 - 9 32	734	68	Lageos	17
5		16 8 36 - 8 40	286	158	Ajisai	8
6		16 9 53 - 10 13	1333	97	Lageos	14
7		17 8 30 - 8 56	558	419	Lageos	14
8		17 12 17 - 12 26	312	121	Lageos	13
9		18 10 31 - 10 50	490	686	Lageos	12

Table 6. Results of geometrical collocation analysis

No.	time		satellite	$\bar{D}$	r.m.s.	used orbit*
	h	m		cm	cm	
1	1987 Dec. 13	9	Ajisai	0.1	5.8	a
2		13 10	Lageos	-0.9	4.5	b
3		14 8	Ajisai	1.1	4.9	a
4		14 8	Lageos	-2.8	4.3	b
5		16 8	Ajisai	-1.9	11.1	c
6		16 9	Lageos	0.4	3.7	d
7		17 8	Lageos	-0.9	4.1	e
8		17 11	Lageos	-0.5	4.1	e
9		18 10	Lageos	-4.3	5.9	f
average				-1.08	5.4	

\* see Table 4

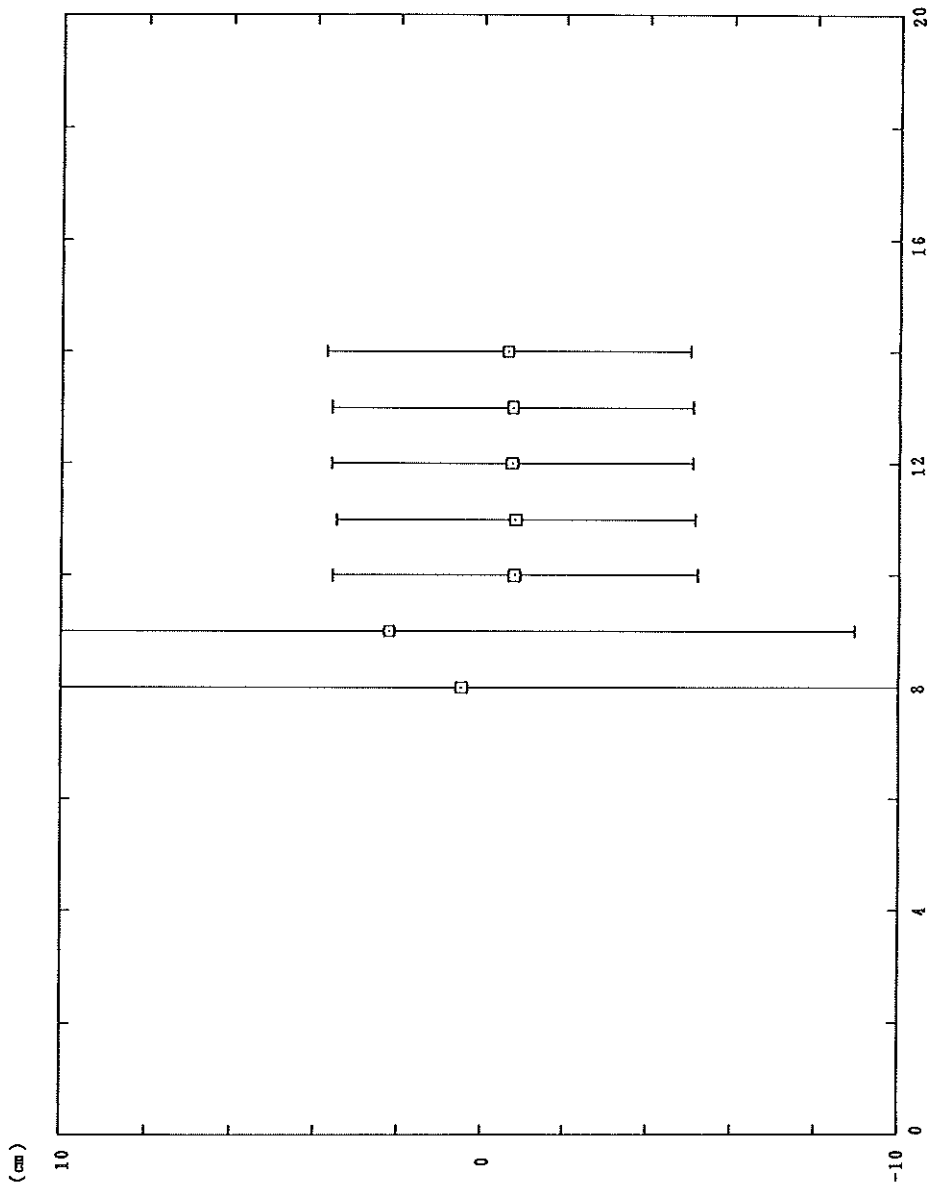

Figure 6. Polynomial order-D

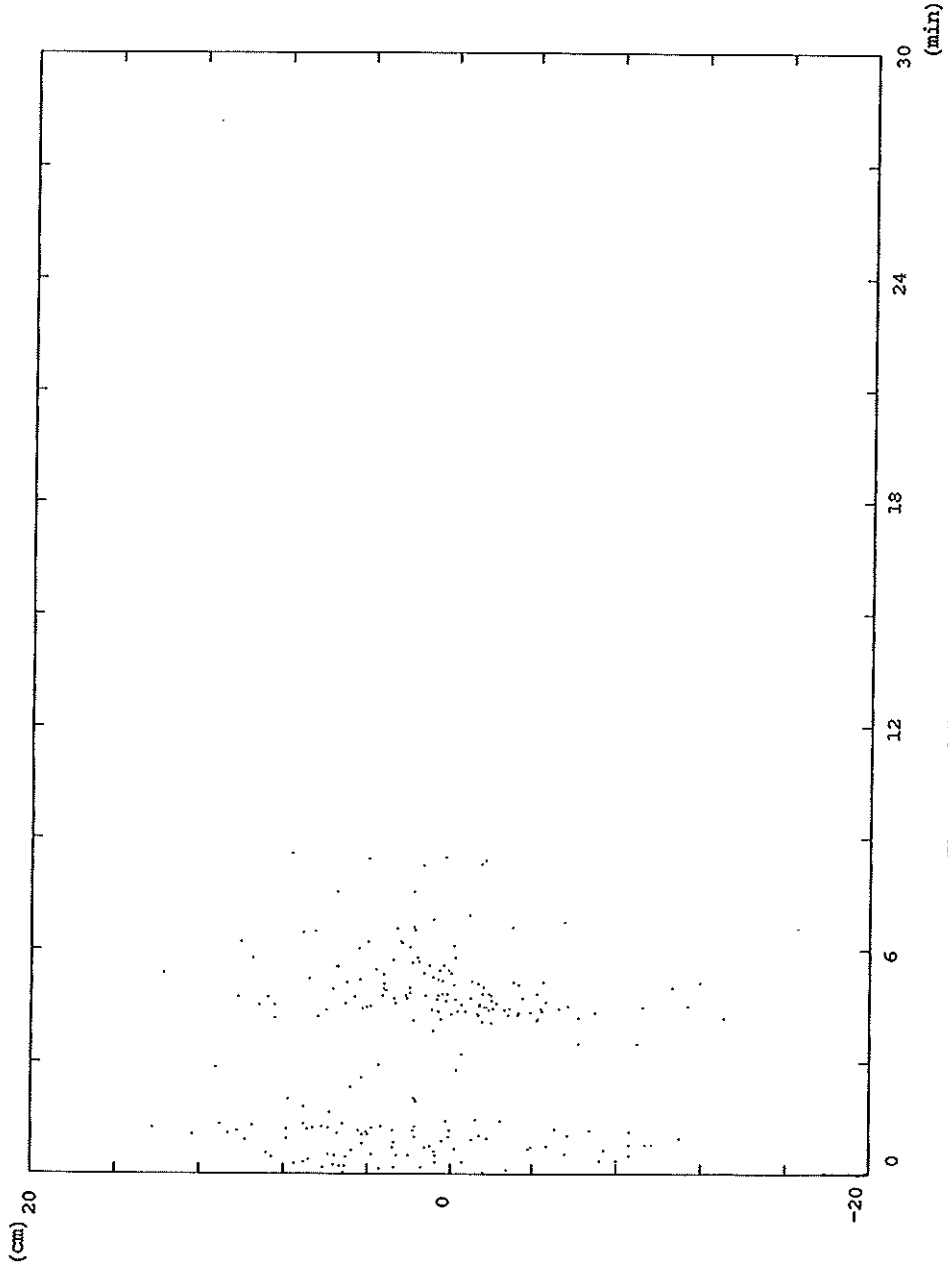

Figure 7. Collocation analysis (Dec.14,1988), Ajisai

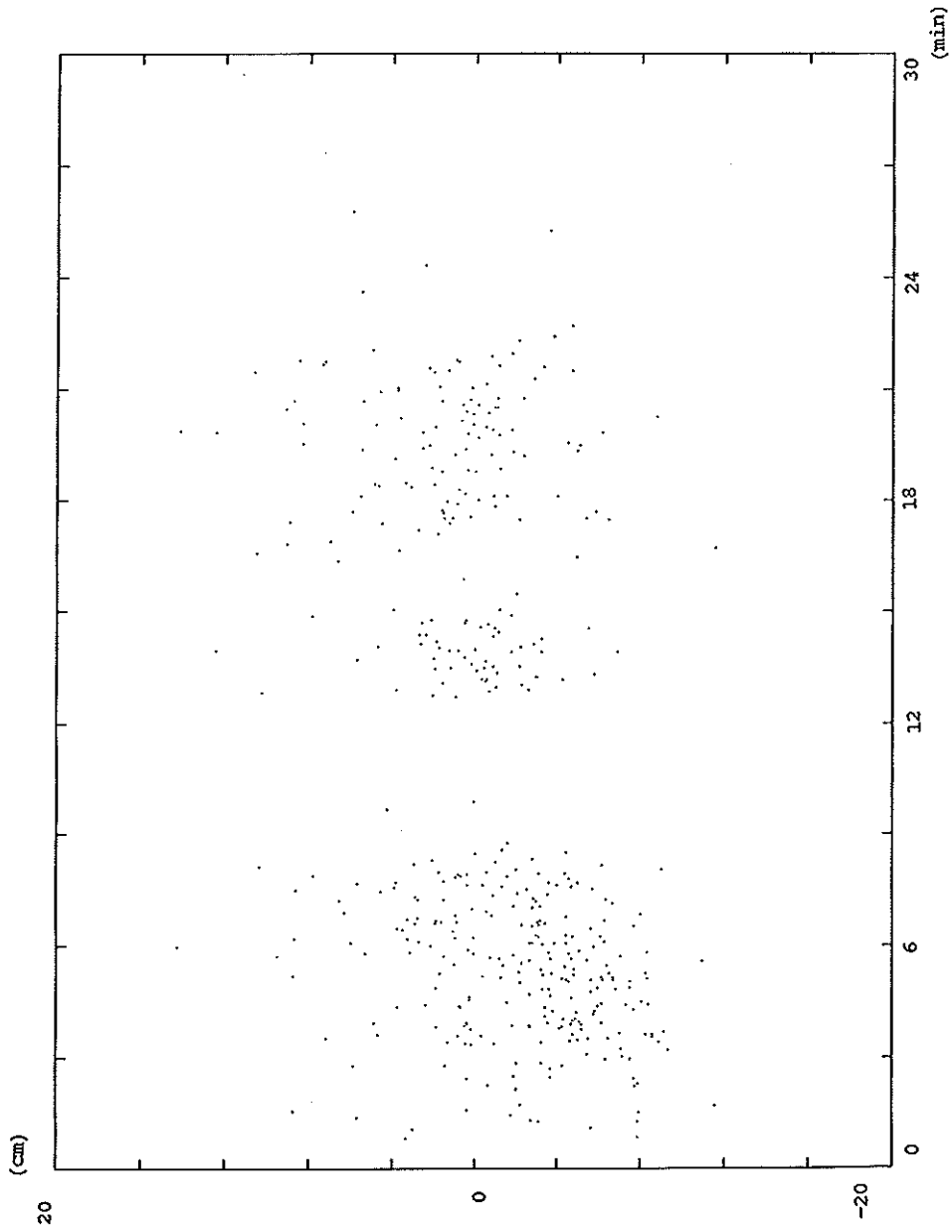
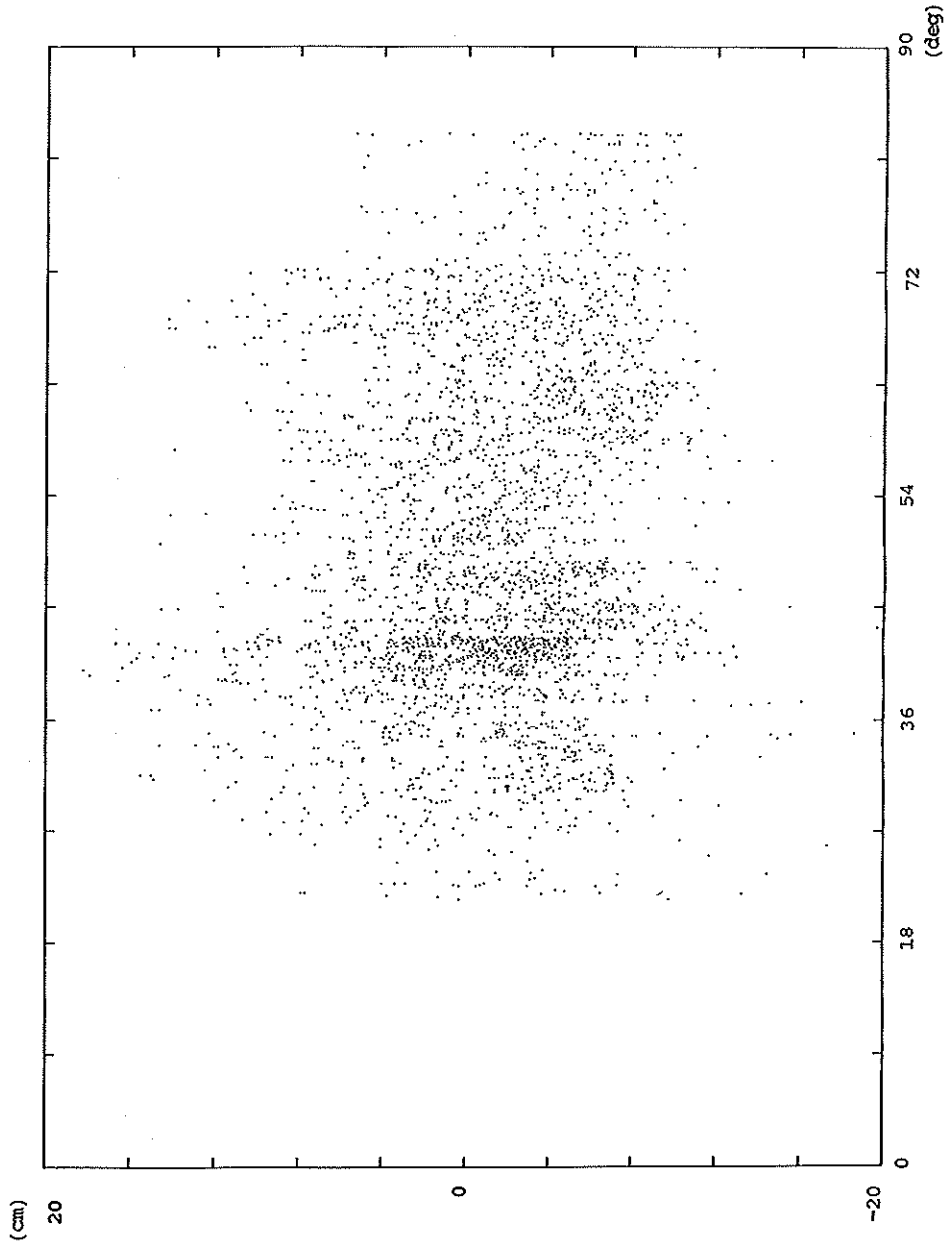

Figure 8. Collocation analysis (Dec.13,1988), LAGEOS





Figurs 9. Elevation dependance (Dec.1987)

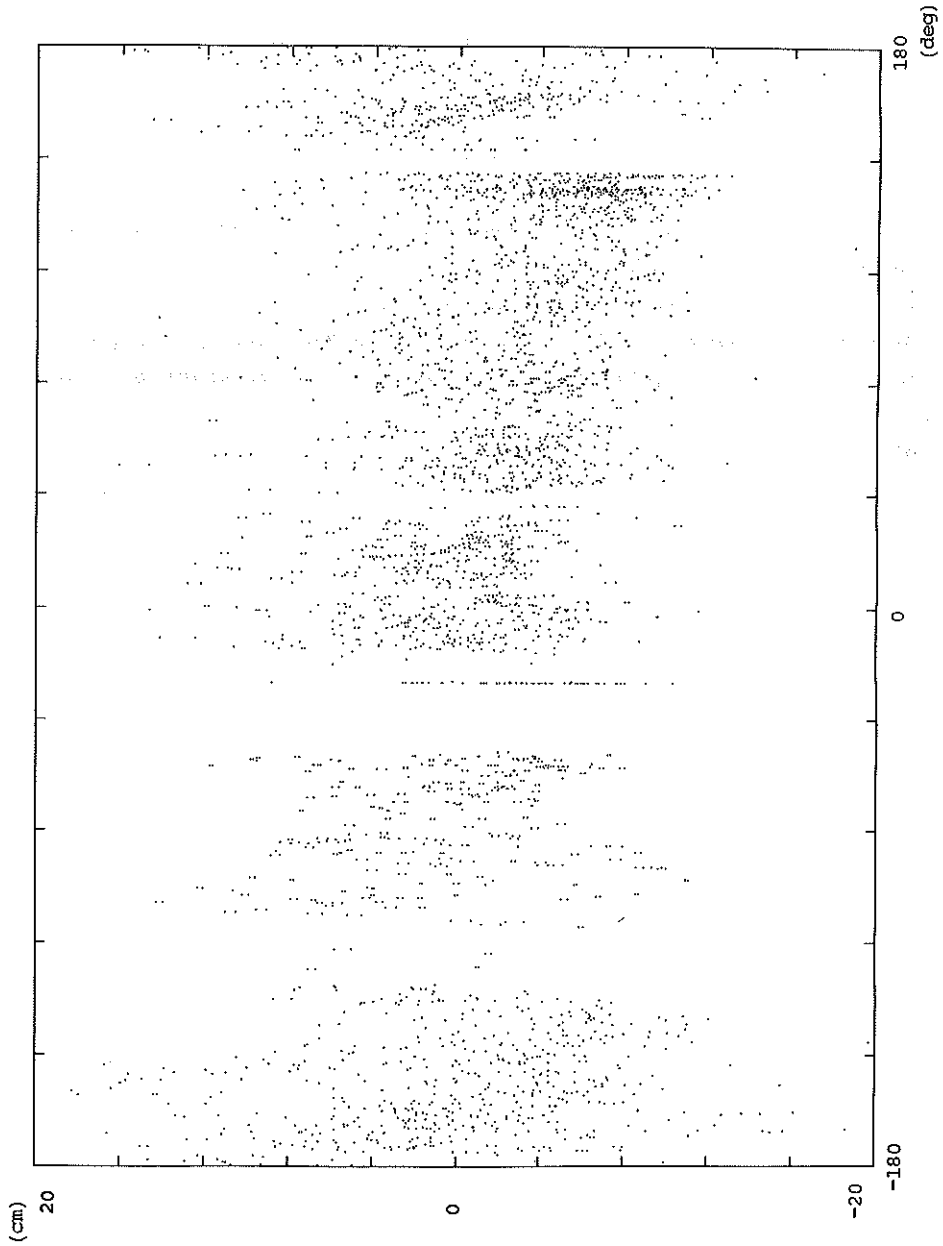

Figure 10. Azimuth dependence (Dec. 1987)

Collocation observation was made by T. Kanazawa, T. Uchiyama, M. Nagaoka and K. Fuchida. Reduction of survey was made by M. Nagaoka. The analysis of collocation observation was made by A. Sengoku.

This report was written by A. Sengoku of Satellite Geodesy Office.

#### References

- Sasaki, M., Ganeko, Y., Harada, Y. 1983: *Data Report of Hydrogr. Obs., Series of Astronomy and Geodesy*, No. 17, p.49.
- Sasaki, M. 1984: *Report of Hydrogr. Researches*, No. 19, p.107.
- Sasaki, M. 1987: *Data Report of Hydrogr. Obs., Series of Satellite Geodesy*, No. 1, p.59.
- Takemura, T. 1983: *Data Report of Hydrogr. Obs., Series of Astronomy and Geodesy*, No. 17, p.44.
- BIH 1988: *Circular D 255*.

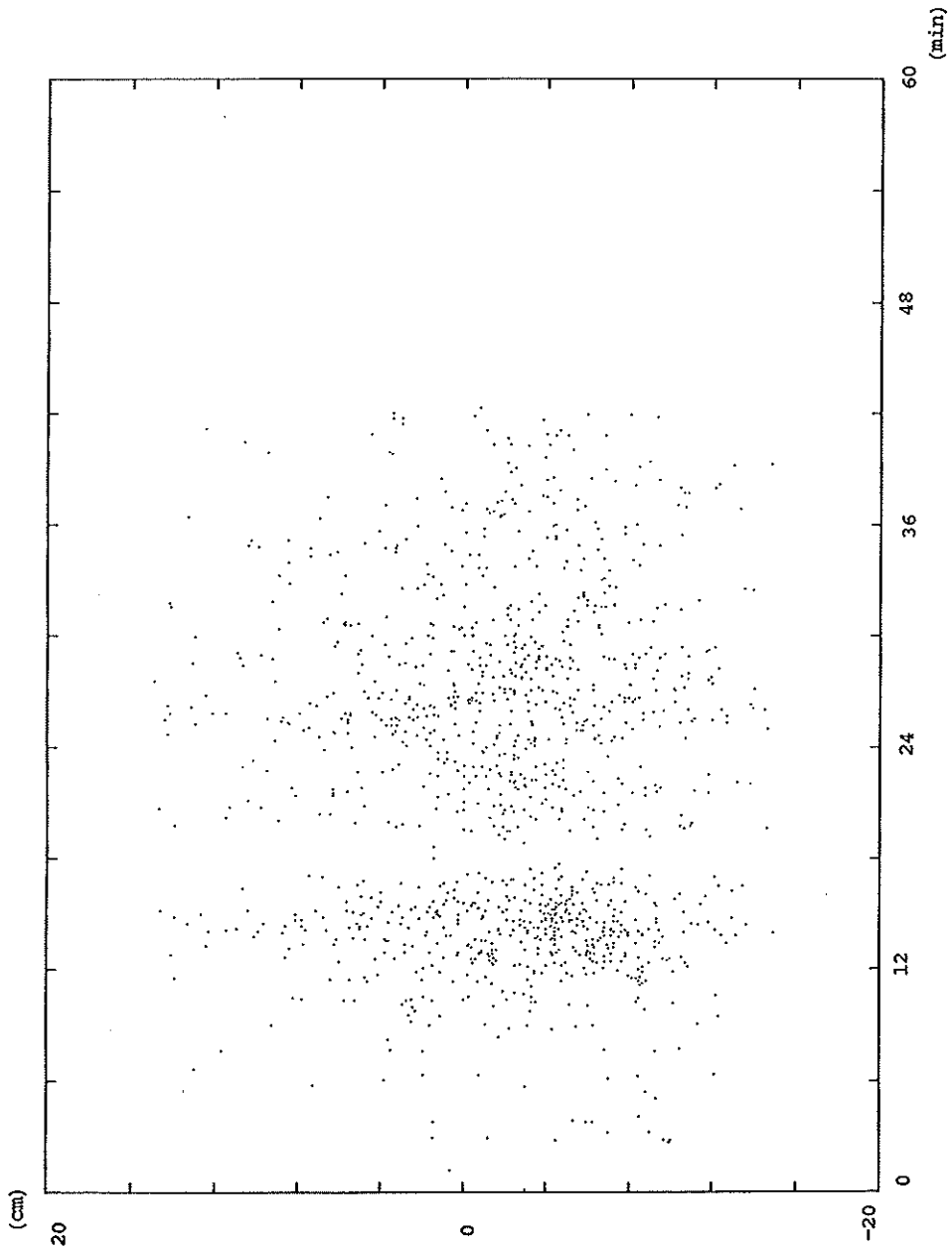

Figure 11. Residual of dynamical analysis (Dec.13,1987), Lageos

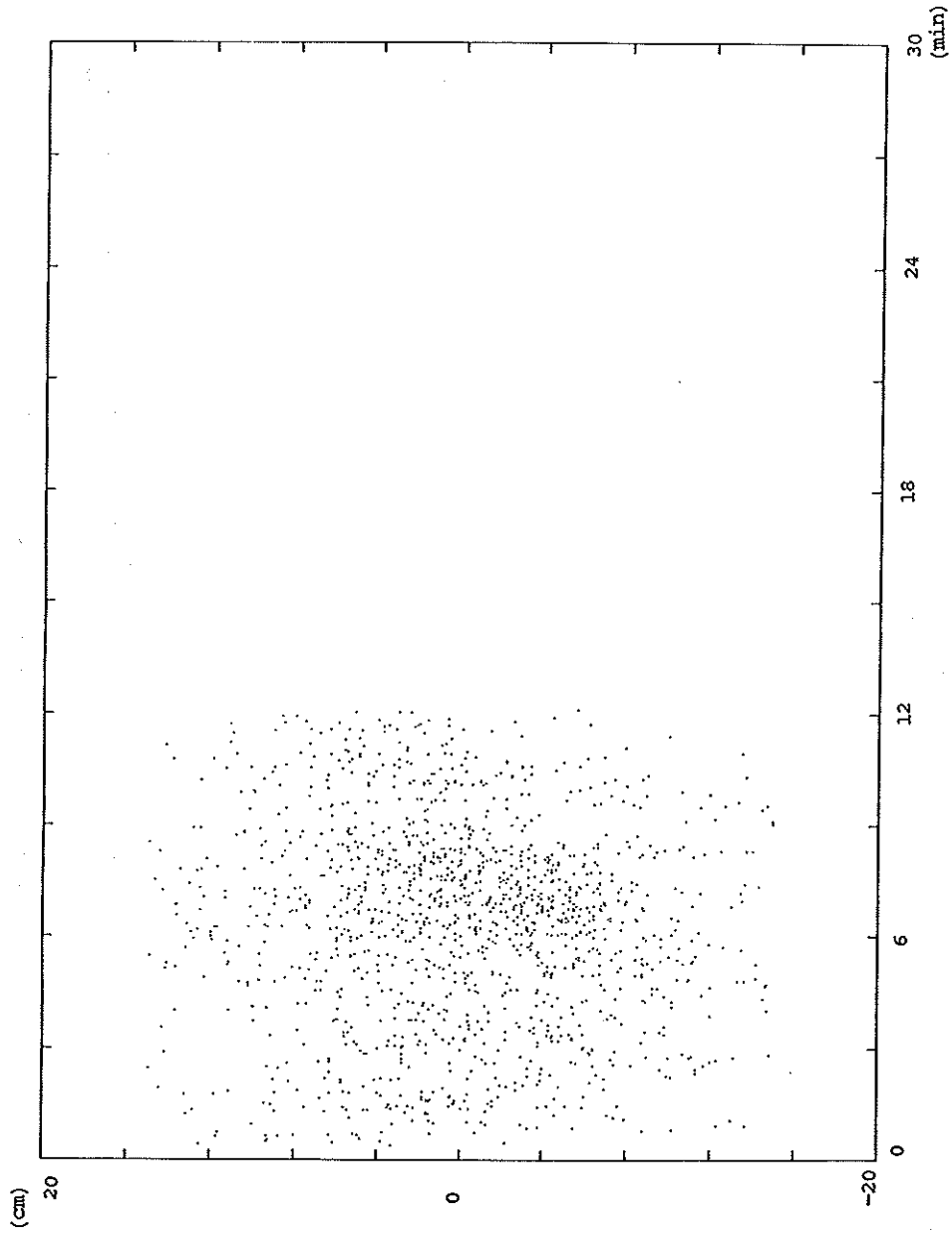

Figure 12. Residual of dynamical analysis (Dec. 13, 1987), Ajisai

Table 7. Difference of residuals of HTLRS and SHOLAS

No.	time		satellite	residuals		difference
				SHOLAS	HTLRS	
		h		cm cm	cm cm	cm
1	1987 Dec. 13	9	Ajisai	$0.2 \pm 6.6$	$-0.1 \pm 5.3$	-0.3
2		13 10	Lageos	$-1.5 \pm 6.5$	$-2.6 \pm 4.2$	-1.1
3		14 8	Ajisai	$-1.0 \pm 6.0$	$-0.4 \pm 5.0$	0.6
4		14 8	Lageos	$-3.6 \pm 6.8$	$-6.5 \pm 4.4$	-2.9
5		16 8	Ajisai	$-0.3 \pm 6.8$	$-1.1 \pm 4.8$	-0.8
6		16 9	Lageos	$-1.3 \pm 6.4$	$-0.9 \pm 3.3$	0.4
7		17 8	Lageos	$-0.7 \pm 6.6$	$-1.9 \pm 4.1$	-1.2
8		17 11	Lageos	$-1.1 \pm 6.5$	$-1.2 \pm 4.1$	-0.1
9		18 10	Lageos	$0.7 \pm 6.0$	$-2.5 \pm 4.1$	-3.2
average						-0.96

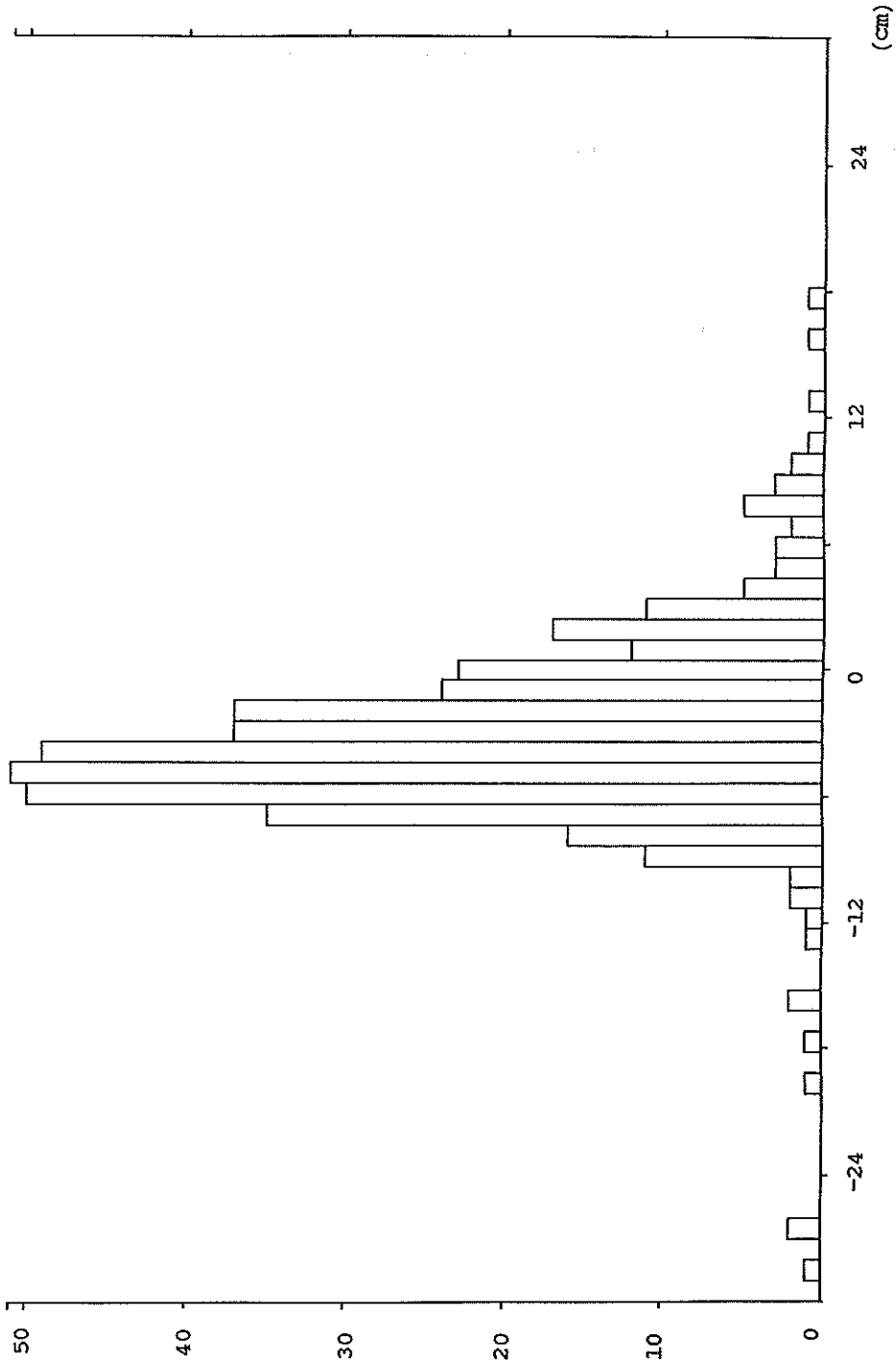

Figure 13. Histogram of residuals of HTLRS (Dec. 17, 1987, Lageos)

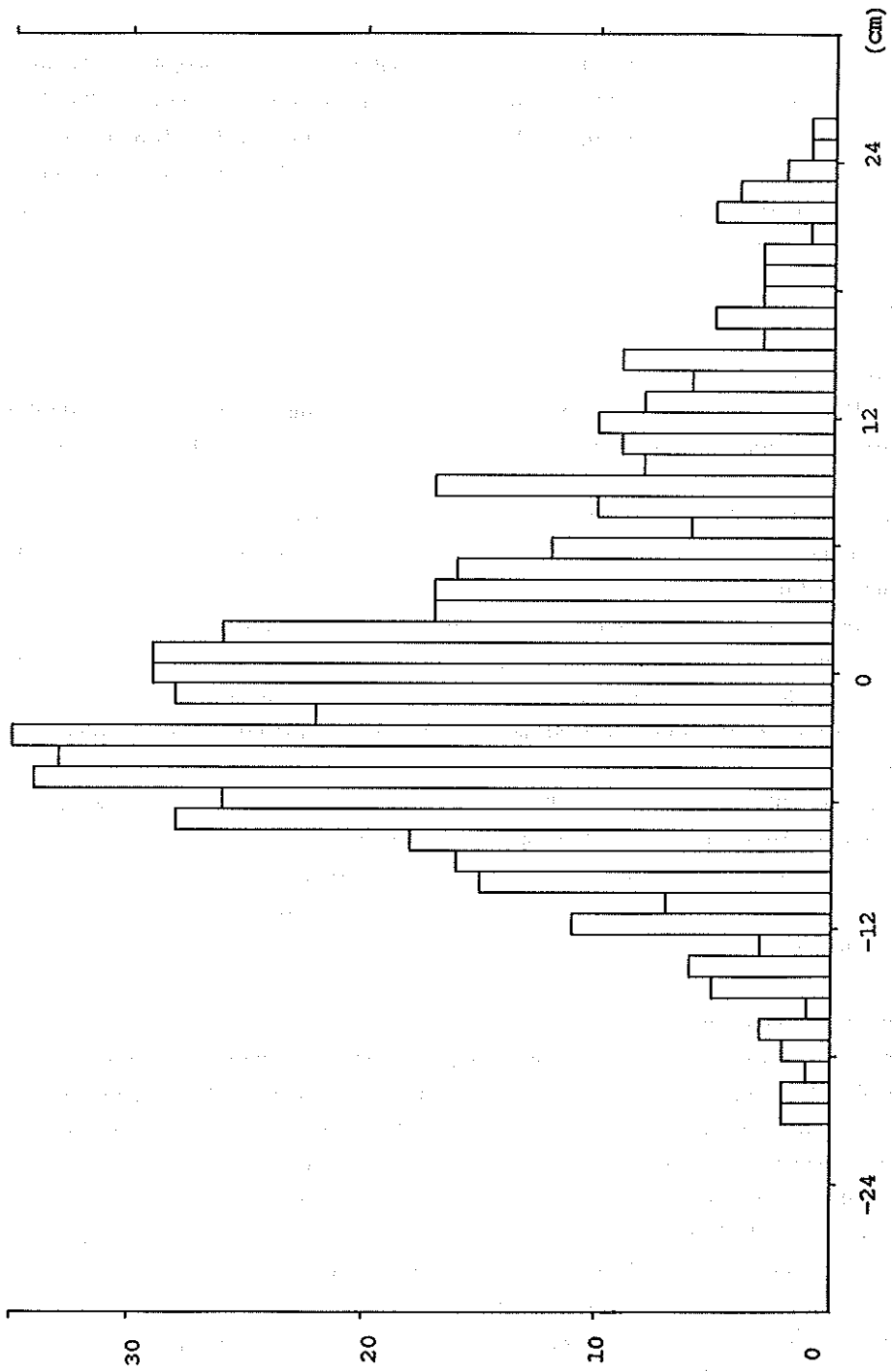

Figure 14. Histogram of residuals of SHOLAS (Dec. 17, 1987, Lageos)



## THE NEW SATELLITE CAMERA FOR GEODESY

**Summary** — A new satellite camera was installed in the Simosato Hydrographic Observatory in November, 1987. It has been utilized to take photographs of Japanese Geodetic Satellite "Ajisai" and the data are incorporated with satellite laser ranging data to determine the positions of the isolated islands of Japan. The new camera has some special specifications as well as the usual functions of an astronomical camera. The designs and functions of the camera are described in this report.

**Key words:** satellite camera — Ajisai — marine geodetic control network

### 1. Introduction

The Hydrographic Department of Japan has been carrying out a project to establish the marine geodetic controls around Japan. The project consists of three stages (Kubo, 1988):

- a) the connection of the Tokyo Datum to a world wide geodetic system,
- b) the connection of the principal off-lying islands (the first order control points) to the Tokyo Datum,
- c) the connection of the second order control points to the first order ones.

To connect the first order control points to the Tokyo Datum, the method of the Satellite Laser Ranging and direction observation by photographing of Japanese Geodetic Satellite "Ajisai" at the Simosato Hydrographic Observatory (SHO) and on the islands are adopted.

A new satellite camera was installed at SHO in November, 1987 for the purpose of photographing Ajisai, and the simultaneous observation between SHO and a first order point began in January, 1988. The new camera has some special specifications beside the usual functions of an astronomical camera. The designs and functions of this new camera are described below.

### 2. General design of the system

The satellite camera (Figure 1) is an astronomical telescope with a plate holder which is controlled by a micro computer with time keeping devices (Figure 2). The computer and time keeping devices are set in the control room and the telescope is housed in the observation room which has a sliding roof (Figure 3). The telescope consists of optics, a plate holder and an equatorial mount. The driving mechanism of the polar axis of the mount is unique to attain a high precision direction keeping during an exposure of a plate. The plate holder can contain up to 4 plates and the exchange of plates is done automatically. The computer controls the direction of the telescope, exposures and exchanges of plates. The clock is calibrated by the JJY time signal. So, operators may input the information to the computer prior to an observation so that the pointing of the telescope and the exposures of plates are made automatically under control of the computer.

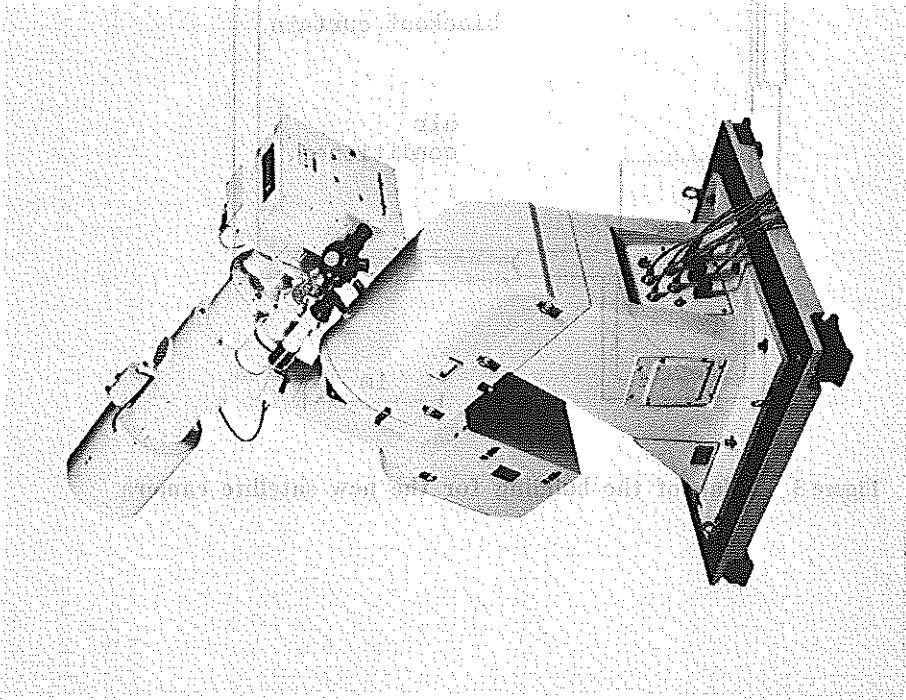

Figure 1. Telescope and mounting of the new satellite camera

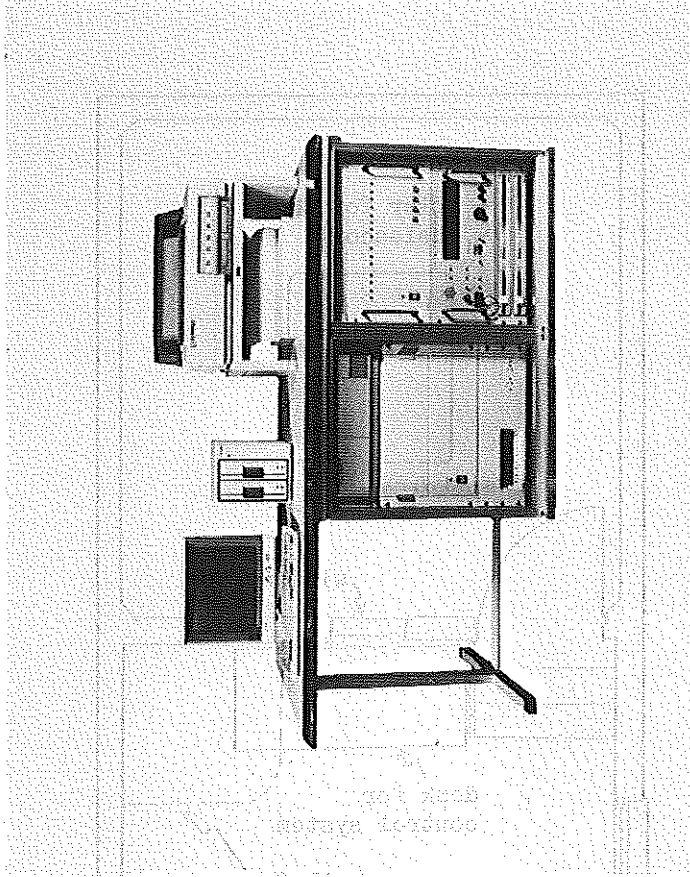

Figure 2. Computer and clock system of the new satellite camera

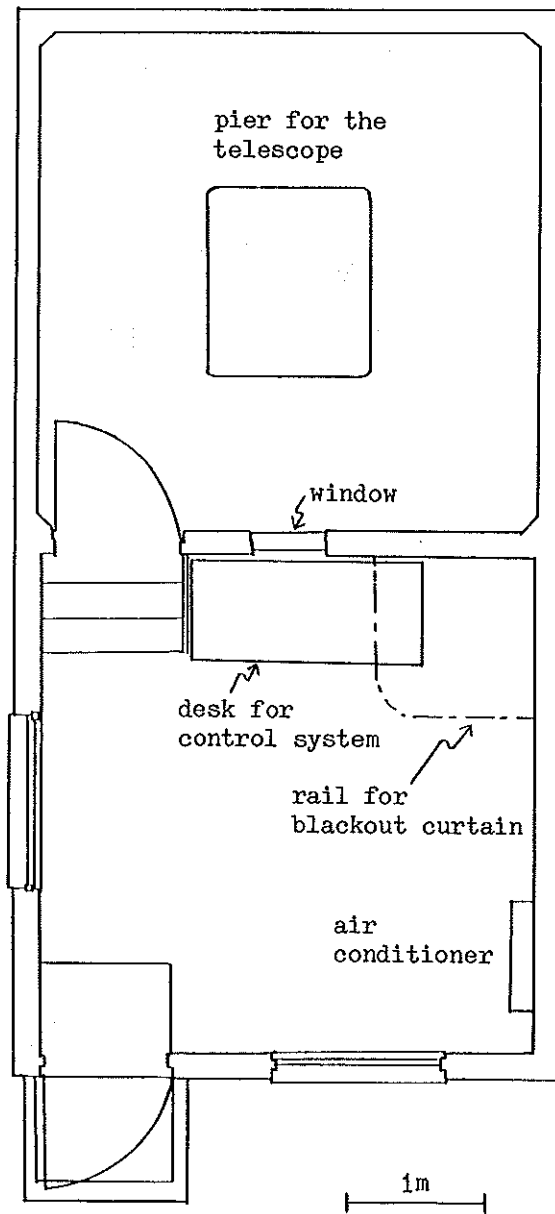

Figure 3. Plan of the building for the new satellite camera

### 3. Optics

The optics consist of main refracting system and two finders. The specifications of these lens systems are listed in Table 1.

The specifications of the main refracting system were determined considering the goal of the precision assumed in the project, that is, the precision of the measurement of the direction of the satellite by comparing the positions of the images of the satellite to those of the stars taken on the plate. Ajisai is equipped with mirrors to reflect the sunlight and flashes a few times a second (Kanazawa, 1987). The speed of Ajisai moving in the sky is about 1000 seconds of arc per second at high altitude and moves about 3 degrees in 10 seconds. Ajisai flashes about 20 to 30 times during 10 seconds. At the same time, a few tens of stars are recorded on the same plate and the positions of these stars make the reference coordinates to determine the direction of Ajisai in the sky at each flash. The position of each flash to 0.5 second of arc being measured, satellite direction will be obtained to the precision of 0.1 second of arc with one plate. The timing of these flashes are recorded by another telescope attached to the laser ranging system.

### 4. Plate holder

The size of plates is 125 mm  $\times$  175 mm (5 inches  $\times$  7 inches). Up to 4 plates can be contained in the plate holder. The plate to be exposed is sustained by three pins and the focus is adjusted by moving these pins with micrometers. A focusing glass or a knife edge method is used to adjust the focus. The shutter is made up of 5 blades and a device to lower the vibration of the shutter when it opens is attached. Plates are exchanged by an automatic mechanism. The exposure time and period, scheduled direction and serial number of the plate are exposed at one corner of the plate.

### 5. High precision sidereal drive

The mount of the telescope is German type equatorial. The polar axis and the declination axis can be rotated up to 2 degrees/sec by DC motors. The direction of the telescope is measured by two inclinental encoders which are attached to the both axes. Siderial motion of the polar axis to follow the rotation of the earth is driven by a pulse motor while keeping the direction of the telescope to a point in the sky. In addition to it, a mechanism to keep the siderial motion of the telescope in high precision (Figure 4) has been devised to match with the goal of the project. In this mode, a pulse motor rotates an axis which transfers the rotation to the polar axis through a tangential screw so that a small portion of the circular motion of the polar axis is substituted by a linear motion. The length of the arm which drives the axis is about one meter. Since it is much longer than the radius of a usual gear, high precision in following the siderial motion (Figure 5) is achieved. Although the duration that this mechanism is effective is within 10 minutes, it is enough to take photographs of Ajisai.

### 6. Micro computer and time keeping devices

A crystal clock is used to keep time and the 1 pps signals of the clock are calibrated by

Table 1. Specifications of the optical system

(1) Main refracting system	
effective aperture	200 mm
focal length	998.3 mm
lens system	apochromat (2 groups, 6 lenses)
effective wave length	400 nm – 650 nm
field of view	$\geq 5$ degrees of diameter (within 4 degrees free from marginal darkening)
diameter of the star image of limiting magnitude	$\leq 45 \mu\text{m}$ (within 3 degrees of diameter in the field of view)
symmetry of the star image	$\leq 0.5$ seconds of arc (within 4 degrees of diameter in the field of view)
positional error after removing plate constant effect	$\leq 0.5$ seconds of arc (within 4 degrees of diameter in the field of view)
(2) Finder 1	
aperture	76 mm
magnification	15.2, 27, 54.1 (revolver type)
maximum field of view	about 4 degrees
eyepiece	with cross hair and electrical illumination of the cross hair
(3) Finder 2	
aperture	50 mm
magnification	6.6
field of view	8.8 degrees
eyepiece	with cross hair and a circle of 4 degrees in diameter, with electrical illumination of the cross hair and the circle

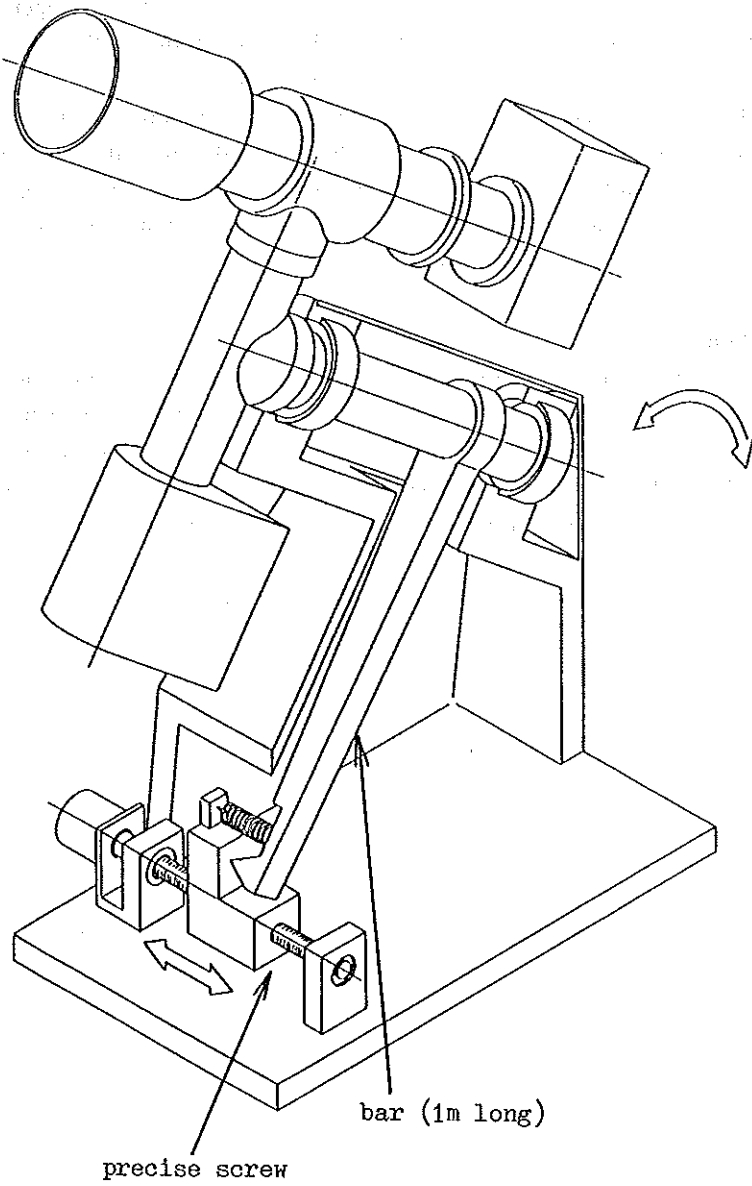

Figure 4. Mechanism of the high precision sidereal drive

signals from a JJY receiver. Time signals from the clock is sent to the micro computer and used to control the telescope direction and the disposure of the plates.

The micro computer controls whole sequences of an observation. The operator inputs the information about the observation that he is going to make, that is, the direction of the telescope to point, the beginning time of an exposure of a plate, the exposure period, the number of the plate etc. The program of the computer is easily operated through a menu display. When the parameters are properly set, the observation is made automatically. All kinds of operations can be done manually too by using a hand box. A data file about the observation is compiled in the computer after observation including the meteorological data and comments that the operator inputs.

### 7. Observations

The first simultaneous observations of Ajisai with this satellite camera and with the transportable astro-camera which was set in Titi-Sima were made from January to March, 1988. An example of the plate taken during this period is shown in Figure 6. Ajisai appears as dots on a line. The second simultaneous observations of Ajisai were carried out from July to September, 1988 between Simosato and Isigaki-Sima. In the project, two observation series are planned during one year.

This equipment is designed to determine satellite direction to high precision as described above. It will also be effective for other purposes such as asteroid observations and comet observations.

This report was prepared by T. Kanazawa of the Satellite Geodesy Office.

### References

- Kanazawa, T. 1987: *Data Report of Hydrogr. Obs., Series of Astronomy and Geodesy*, No. 21, p.90.  
Kubo, Y. 1988: *Data Report of Hydrogr. Obs., Series of Satellite Geodesy*, No. 1, p.1.

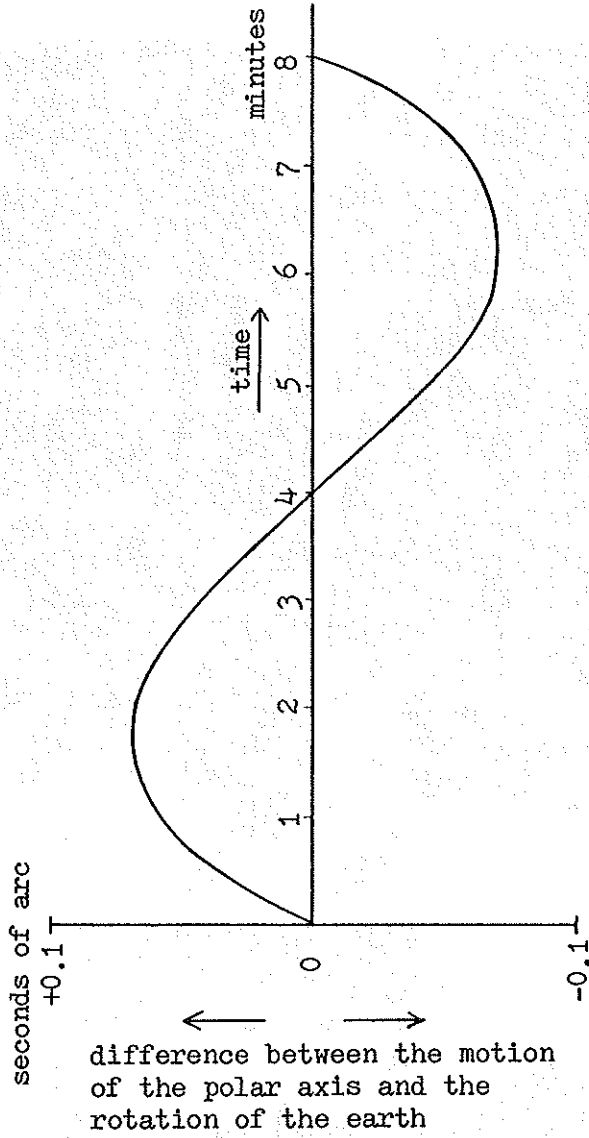

Figure 5. Expected error in the high precision sidereal drive mode



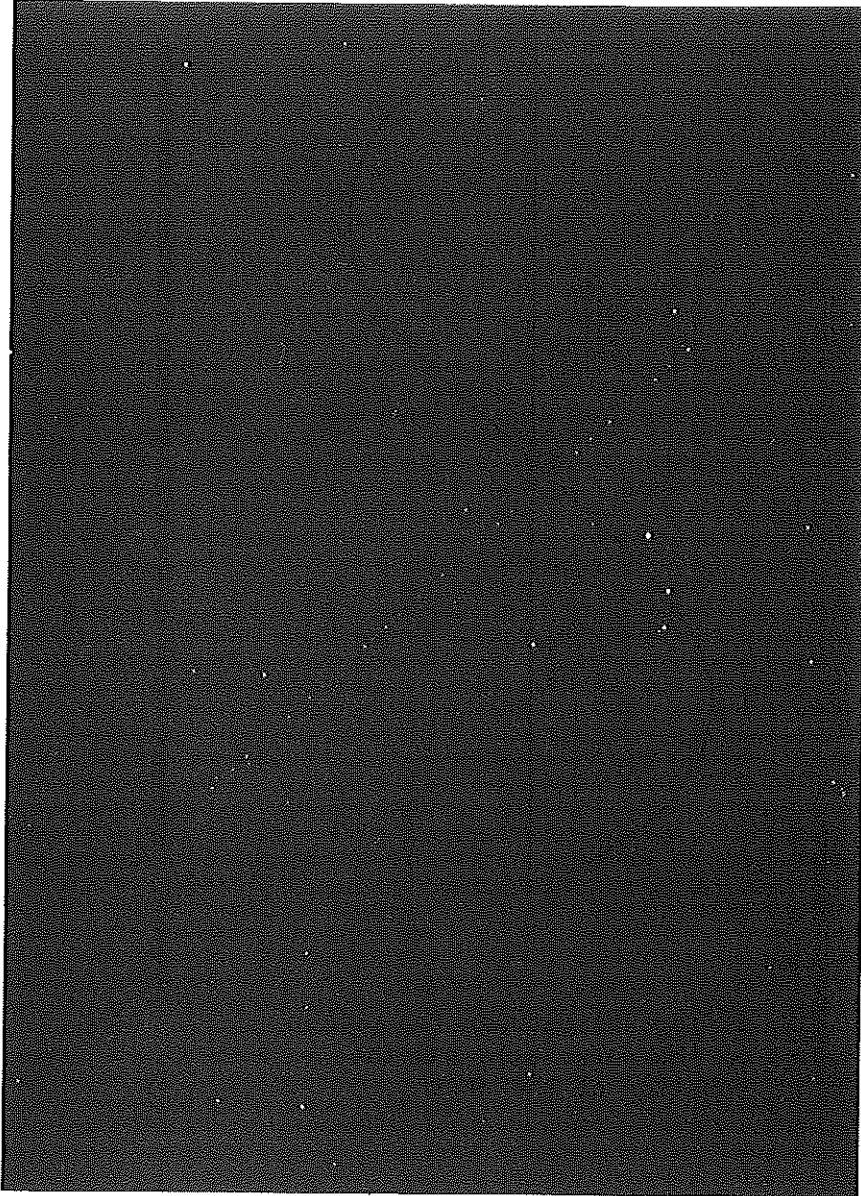

Figure 6. Example of the plate

## 衛星データ整約装置

### SATELLITE DATA ANALYSIS COMPUTER SYSTEM

For the purpose of processing the various data of the geodetic satellite Ajisai consisting of laser ranging data and direction data by photographs, a satellite data processing system was introduced at Satellite Geodesy Office in January, 1988. The system is composed of several mini-computers, graphic displays, disk driving units, printers and so on connected to each other by LAN.

Key word : Satellite data - Data processing system.

海洋測地の推進計画においては、本土基準点及び一次基準点において同時に測地衛星「あじさい」のレーザー測距観測及び写真方向観測を行い、得られたデータを解析することによって高精度な一次基準点の位置を決定する。衛星測地室では、これらの測地観測データの選別、補正、標準化等を行い、位置決定のための総合ファイルを集める目的のために、昭和63年1月、衛星データ整約装置を導入した。以下、装置構成、システム構成及び運用管理について報告する。

#### 1. 装置構成

##### 1. 1 全体仕様

衛星の測地観測データは、測距データ、方位データ及び時刻データとそれぞれ種類の異なるデータであり、この異なるデータの相互変換、相互比較、混合等の処理は、反復計算を行う膨大な作業であるため、衛星データ整約装置の機能には、その内部処理も、人間とのインターフェイスも高度であることが要求された。

- 1) 高速処理（高性能なフローティング演算）
- 2) 大量なデータの保管（光ディスク装置）
- 3) データの共有、統合（ネットワーク・ファイルシステム）
- 4) データの多様な表現（文字、図形、画像）
- 5) 優れたソフトウェアの導入（プログラム開発支援）
- 6) オフィス環境でのアクセス（大きさ、温度、湿度）

最も望まれた機能は、高速処理である。衛星測地室で作成したベンチマーク・テストにより性能をチェックし選定を行った。性能を高めるため総合記憶容量は80MB、ネットワーク上に固定したハードディスクの容量は、2GBとなった。

##### 1. 2 装置構成

衛星データ整約装置は、データ演算部、データ記憶部、データ編集部、データ入出力部、フロッピーディスクデータ変換部及び出力切換部の各部から構成される。



写真1. HP9000/825S



写真2. HP9000/350Cと磁気テープ装置

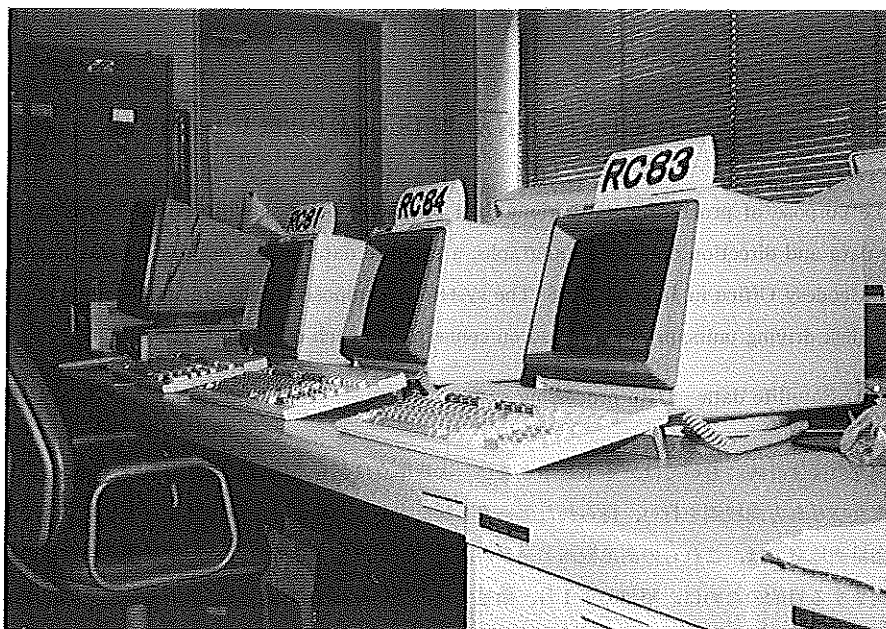

写真3. 19インチカラーディスプレイ

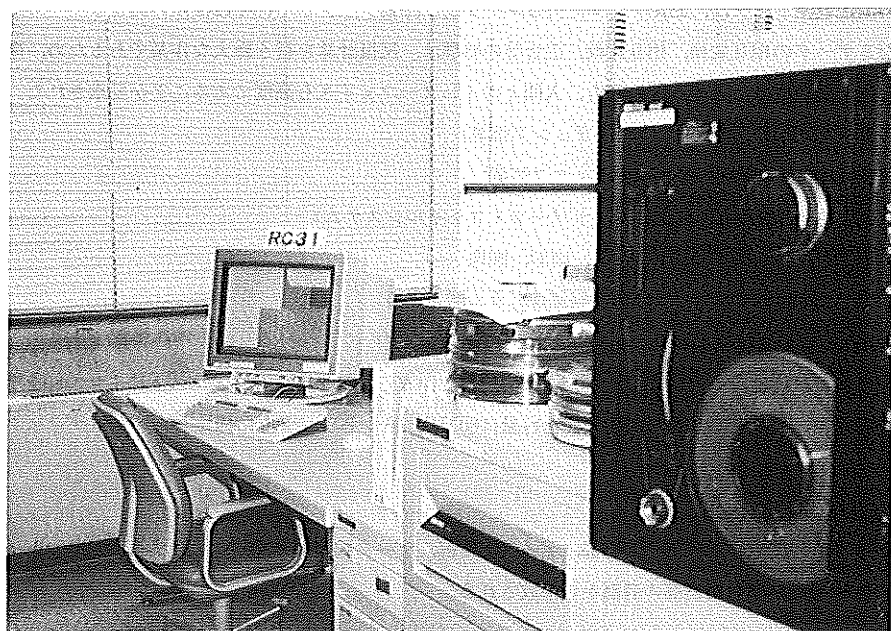

写真4. 出力例：衛星の直下点飛跡

装置の構成はデータ演算部の HP9000/825S を中心とし、LAN でむすばれた分散環境になっている。ハード的には、機器を並列に固定して処理作業を行い、高速化をはかり、処理手続きには対話形式を採用し、ネットワークを介して情報の共有化をはかっている。

装置の構成図を図-1に示す。

ネットワーク上の処理機器にはノード名をつけて運用している。HP9000/825S のノード名は rc81-rc84、HP9000/350C は rc31-rc34、HP9000/318M は rc35、rc36である。

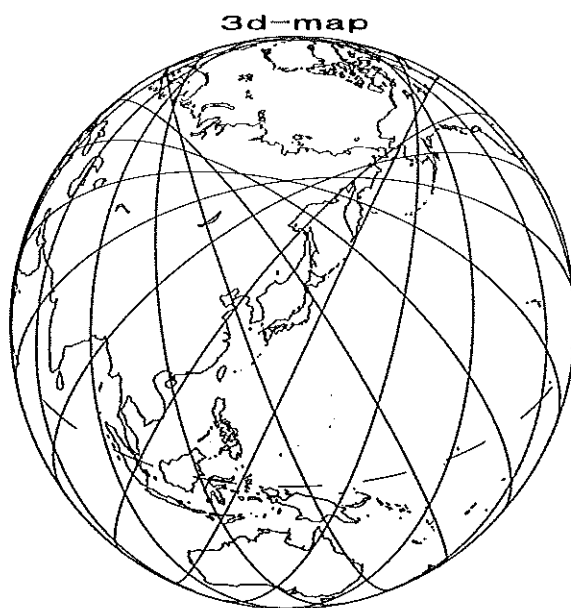
データ記憶部の光ディスク装置、フロッピーディスクデータ変換部のフロッピーディスク・ドライブ及びレーザープリンタは PC9801-UV21で制御している。

### 1. 3 機器性能

機器の性能を表-1に示す。

## 2. システム構成

### 2. 1 オペレーティングシステム

オペレーティングシステムは、HP-UX を使用している。UNIX System V をベースに UNIX 4.2BSD 及び HP 拡張機能が付加されたものである。HP9000シリーズ800はリビジョン2.0、シリーズ300はリビジョン6.0を使用している。

### 2. 2 ネットワーク

ネットワークの物理的構成は、同軸ケーブルによる10Mbit/秒のイーサネットを使用している。ネットワークを介したファイルシステムの共有には、NFSを導入した。UNIXにおけるファイルの供用に関する技術は、1980年代の始めに開発が行われ、NFS(Network File System)は、1985年に Sun Micro System 社によって開発されている。

衛星データ整約装置の NFS 構成は、シリーズ800及びシリーズ300において各シリーズごとに使用環境を同一とするよう設定している。分散されているファイルシステムは NFS により remote mount することによって仮想に接続され、他の機器に存在するファイルをあたかも自分の機器上にあるかのように扱うことが可能になっている。

シリーズ800では、rc81-rc84において UNIX システムを構築した。HP-UX 開発環境をすべて所有するものは rc81のみで、他はネットワークを経由してブートアップ時にマウントされ結合する。したがって、rc81が停止の状況では、シリーズ800は作動しない。

シリーズ300は、rc31-rc33及び rc34-rc36において UNIX システムを構築している。この二つのシステムにおいて、UNIX 開発環境をすべて所有するものは rc32と rc34である。rc35、rc36はディスクレスで運用している。

### 2. 3 ファイル構成

シリーズ800のファイル構成図を図-2に、シリーズ300のファイル構成図を図-3に示す。ファイルは物理的には複数のディスクに分散していても、ファイル構成は、シリーズにおいて各ノードに共通しており、利用者はシリーズ内ではどのノードを使用しても同じ環境で作業できる。



図1. 機器構成図

名 称	機 器	数	備 考
データ演算部	HP9000/825S	4	記憶容量 8MB, ハードディスク 307MB キャッシュメモリ 16KB, 命令処理能力 8.2MIPS
データ記憶部	PC9801/UV21	1	RAM 1MB, ハードディスク 40MB 数値データプロセッサ付
	光ディスク装置	1	(PIONER DD-8001) 8 インチ両面1.5GB
データ入出力部	HP9000/350C	3	記憶容量 8MB, ハードディスク 130MB キャッシュメモリ 32KB, 命令処理能力 4.1MIPS
	磁気テープ装置 (6250BPI)	1	リード/ライト 125インチ/秒 リワインド 320インチ/秒
	磁気テープ装置 (1600/800BPI)	1	リード/ライト 100インチ/秒 リワインド 200インチ/秒
	磁気テープ装置 (カセット)	1	リード/ライト 60インチ/秒, リワインド 90インチ/秒 16MB, 67MB カートリッジ使用
	レーザージェットプリンタ	1	(HP) 印字速度 8枚/分 (A4)
データ編集部	HP9000/318M	2	記憶容量 8MB, ハードディスク 130MB 命令処理能力 2.3MIPS
	PC9801/UV21	1	RAM 1MB, 数値データプロセッサ付
	インクジェット漢字プリンタ	1	(EPSON HG2500)
画像出力部	PC9000/350C	1	記憶容量 8MB, ハードディスク 130MB キャッシュメモリ 32KB, 命令処理能力 4.1MIPS
	X, Yプロッタ	1	(HP) 分解能 (位置指定) 0.025mm ペン 8本, ペン速度 (最高) 80cm/秒
フロッピーディスク データ変換部	PC9801/UV21	2	RAM 1MB, 数値データプロセッサ付 ハードディスク 40MB (1台)
	フロッピーディスク ドライブ (8")	1	1MB タイプ
	フロッピーディスク ドライブ (5")	1	640K/1MB 両面タイプ
	レーザービームプリンタ	1	(Canon LBP-B406) 漢字第2水準 印字速度 6枚/分 (B4) 8枚/分 (A4)
出力切換部	出力切換装置	3	(メルコ EX-512) 入力2, 出力2

表1. 機器性能表



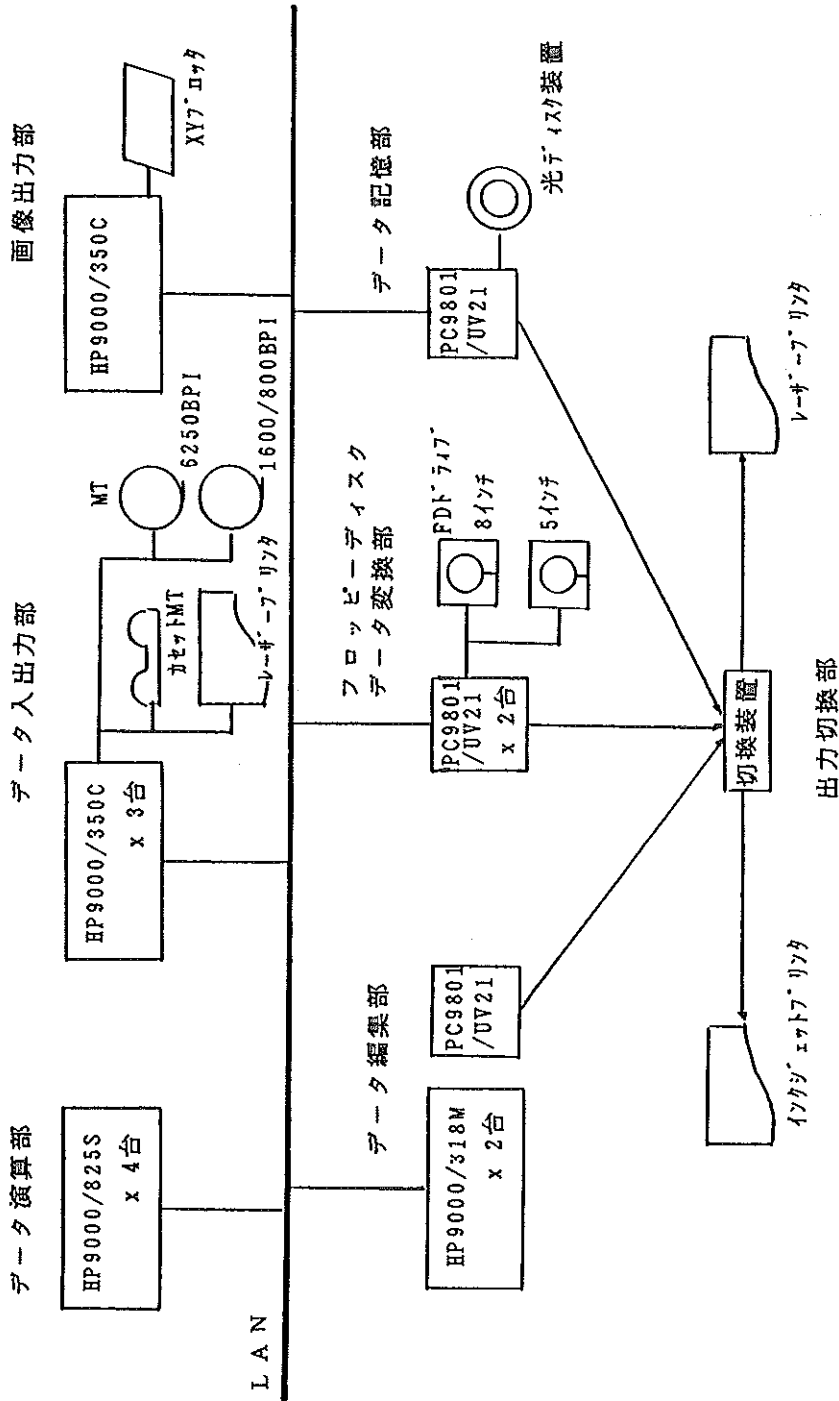

## 2. 4 ソフトウェア

衛星データ整約装置には、以下に示すソフトウェアを装備している。

- 1) データ入力ソフトウェア  
Emacs エディタ
- 2) データ出力ソフトウェア  
TEX (テフ)
- 3) 処理言語  
C, FORTRAN77, Pascal, Awk
- 4) ウィンドウ機能・ウィンドウライブラリ  
X-window, Hp-window
- 5) 画像出力ライブラリ  
HP-Starbase
- 6) 数値解析・統計ライブラリ  
Space-II

## 3. 運用管理

シリーズ800はバックグラウンドとして使用し、バッチ処理で運用している。シリーズ300では、主に多重ウィンドウシステムを使用して、会話によるデータ処理及びソフト開発を行っている。

## 3. 1 運転時間

運転時間は、原則として、休日を除いた月曜日09時05分から土曜日13時05分までである。必要に応じて連続運転を行う。

## 3. 2 ユーザ管理

UNIXを使用できる利用者はユーザとしてシステムに登録する。衛星データ整約装置のシステムは、図-4に示すように、ユーザを eisei と guest の2つのグループに分けている。eisei のグループには業務、衛星測地室員及びシステム管理を割り当て、guest には衛星測地室員以外の利用者を割り当てている。

GROUP	ID	USERS NAME	
eisei	1000	laser	
		sofp	
		gps	
		tool	
		.....	
		.....	
		.....	衛星測地室の利用者
guest	3000	.....	
		.....	
		.....	
		.....	
		.....	
		.....	衛星測地室以外の利用者
		.....	

図4. 衛星データ整約装置のユーザ

laser, soap, gps, tool, 以外のユーザはシリーズ800には login できない。

### 3. 3 システム管理者

衛星データ整約装置の管理はシステム管理者が行う。システム管理者は衛星測地室長により指名される。

システム管理者は、システム環境の構築、整備、ユーザ管理及びファイル管理等を行い、衛星データ整約装置が常に最良の状態で使用できるよう努めている。また、利用者から操作、及びプログラム開発に関する質問等があれば、可能なかぎり援助も行う。

### 4. まとめ

ネットワーク環境を利用した衛星データ整約装置は、システム管理者の努力があって使いやすいシステムが構築できた。これは以前に衛星測地室で AT&T 社の 3B2 で UNIX システムを使用した経験があったことによる知識、技術及びツールの蓄積があったからで、そうでなければ、導入から運転開始まで混乱もさげられなかったかも知れない。今後も、UNIX システムを有効に使用するには知識、経験の豊かなシステム管理者が必要なことはいうまでもない。現在、システム管理者に補助員 2 名をつけ、システム管理者の後継者を養成している。

資源を共有するような環境では、利用者の意識が基本となる。利用者は良いシステム作りに参画しているという意識が必要である。

導入に際しては、電源系統の見直し、空調が切れたときの夜間の運転、設置のためのレイアウト等も問題点となる。このようなハード面のことは、自明のことといえればそれまでであるが、大切である。

衛星データ整約装置は良好な作業環境を提供してくれている。しかし、将来をみれば、現状はあくまで基礎的な環境にすぎないと思う。本装置のようなデータ処理の技術は、ハードウェア、ソフトウェアともに日進月歩の世界である。つねに、技術的見直しには明確なものをもっていることが必要であろう。

衛星データ整約装置の導入は、レンタル契約による。

## ORBITAL PREDICTION OF AJISAI IN 1987

**Summary** — Prediction of orbital elements of Ajisai has been made by orbital prediction system of Satellite Geodesy Office. These elements are sent to laser ranging observatories.

**Key words:** orbital prediction — Ajisai

### 1. Orbital prediction system

Orbital prediction system for artificial satellites was developed in Satellite Geodesy Office in 1986 (Sengoku, 1988). This system produces orbital elements of artificial satellites from laser ranging data. The accuracy of elements are precise enough for laser ranging.

The orbital prediction system consists of three parts, i.e. data handler, SOAP III and check program.

In data handler, erroneous data are rejected by sum check, some corrections are applied to range data and format conversion is made.

SOAP III, Satellite Orbit Analyzer Predictor ver. III, creates orbital elements from laser ranging data and direction data. This program is written in special language developed by Fukusima (1986). In SOAP III, we estimate JHD elements by least squares method. Definition of JHD elements is as follows:

$n$  : mean motion  
 $\xi_0$  :  $(\text{ecos } \omega)_0$   
 $\eta_0$  :  $(\text{esin } \omega)_0$   
 $i$  : inclination  
 $\Omega$  : longitude of ascending node  
 $\chi_0$  :  $l_0 + \omega_0$   
 $d\omega/dt$   
 $d\Omega/dt$   
 $d(\text{esin } \omega)_0$

where  $e$  is eccentricity and  $\omega$  is argument of perigee. Subscript 0 means values at the epoch. JHD element is good parameter set for nearly circular satellites.

Check program verifies the accuracy of JHD elements produced by SOAP III.

### 2. Summary of quick look data of Ajisai

Quick look laser range data are sent from SHO and GLTN once a week via G.E. Mark III. We usually produce JHD elements from quick look data over two or three weeks. Table 1 is the monthly statistics of quick look data sent to our office in 1987. In total, 1100 passes and 24399 returns at 13 stations were sent to our office in 1987.

Table 1. Monthly statistics of quick look data of Ajisai

1987. Jan.			1987. Feb.			1987. Mar.		
ID	Pass	Return	ID	Pass	Return	ID	Pass	Return
7801	5	111	7838	22	358	1181	8	180
7838	19	283	7840	1	83	7801	2	49
7840	2	50	8405	15	358	7838	15	244
8405	14	330	8502	4	100	7840	6	98
8502	15	375	8605	7	175	8405	3	74
8605	9	196	8704	6	151	8502	3	75
8704	2	51	8805	10	266	8605	4	122
8805	10	251				8704	7	175
						8805	3	78

1987. Apr.			1987. May			1987. Jun.		
ID	Pass	Return	ID	Pass	Return	ID	Pass	Return
1181	7	139	1181	11	236	7801	3	74
7801	3	72	7801	4	98	7838	24	370
7838	12	186	7838	20	316	8405	29	786
7840	20	587	7840	19	256	8605	8	193
8405	12	289	8405	24	575	8805	21	545
8502	3	75	8502	1	25			
8605	2	50	8605	1	25			
8704	4	100	8704	21	520			
8805	12	360	8805	16	409			

1987. Jul.			1987. Aug.			1987. Sep.		
ID	Pass	Return	ID	Pass	Return	ID	Pass	Return
1181	2	36	1181	12	228	1181	1	25
7838	11	179	7801	11	265	7801	1	23
7840	7	96	7838	29	479	7838	18	288
8405	24	594	7840	5	126	7840	7	60
8605	9	222	8405	54	1390	8405	12	299
8704	17	451	8502	9	224	8502	13	325
8805	11	277	8704	24	597	8605	1	25
			8805	48	1186	8704	6	149
						8805	2	51

1987. Oct.			1987. Nov.			1987. Dec.		
ID	Pass	Return	ID	Pass	Return	ID	Pass	Return
1181	2	52	1181	1	25	1181	1	17
7801	8	200	7801	8	200	7834	4	73
7838	18	289	7834	7	158	7838	41	662
7840	3	44	7838	5	81	7839	3	41
8405	7	174	7839	7	84	7840	4	48
8502	3	74	7840	15	177	7907	19	437
8605	7	183	7907	5	120	7939	9	201
8704	10	249	7939	4	91	8405	15	366
8805	3	69	8405	21	514	8502	13	309
			8502	7	174	8605	6	143
			8605	6	151	8704	6	150
			8704	21	517			
			8805	8	212			

- |                          |                              |
|--------------------------|------------------------------|
| 1181 : Potsdam, GDR,     | 7801 : Haleakala, USA        |
| 7834 : Wettzell, FRG,    | 7838 : Simosato, Japan       |
| 7839 : Graz, Austria,    | 7840 : RGO, United Kingdom   |
| 7907 : Arequipa, Peru,   | 7939 : Matera, Italy         |
| 8405 : Mon. Peak, USA,   | 8502 : Yarragadee, Australia |
| 8605 : Mazatlan, Mexico, | 8704 : GSFC, USA             |
| 8805 : Quincy, USA       |                              |

### 3. JHD elements

JHD elements are created once a week by orbital prediction system. Table 2 shows the accuracy of elements after one week ( $\sigma_1$ ) and two weeks ( $\sigma_2$ ). The averages of  $\sigma_1$  and  $\sigma_2$  are 513 m (about 1 arc minute) and 869 m, respectively.

JHD elements created in our office are sent to SHO, Wuhan and Shanghai for laser ranging observation.

JHD elements were created and sent to users by T. Kato and Y. Watanabe, in 1987.

We would like to thank the staff of GLTN who kindly send us quick look data of Ajisai regularly.

This report is written by A. Sengoku.

### References

- Fukushima, T. 1986: *Proc. of the 19th Symp. on Celestial Mechanics*, p.93.  
Sengoku, A. 1988: *Data Report of Hydrogr. Obs., Series of Satellite Geodesy*, No. 1, p.70.

Table 2. Accuracy of JHD elements

sequential No.	creation date	duration of used data	Number of used data	$\sigma_1$ (m)	$\sigma_2$ (m)
	1987	1987			
8	4/09	3/21- 4/06		404	718
10	4/17	3/26- 4/14		608	298
12	4/20	3/26- 4/14		180	372
13	4/25	4/09- 4/21		127	244
15	5/07	4/13- 4/27		389	241
17	5/09	4/21- 5/04		262	727
19	5/19	4/28- 5/12		476	804
20	5/22	5/06- 5/19	1069	390	740
21	5/28	5/09- 5/22	997	419	463
22	6/05	5/19- 6/02	885	162	673
23	6/11	5/27- 6/09	910	494	985
24	6/23	6/02- 6/16		887	543
25	6/25	6/09- 6/23	848	385	1170
26	7/02	6/10- 6/26		1022	443
27	7/24	7/10- 7/21	275	1285	1734
28	7/31	7/14- 7/27	849	881	4224
29	8/10	7/21- 8/04	1323	790	1354
30	8/17	7/28- 8/11	1947	495	1595
31	8/21	8/04- 8/18		327	774
32	8/27	8/11- 8/25	2001	266	646
33	9/03	8/17- 8/31	1826	257	256
34	9/16	8/24- 9/07	1318	282	207
35	9/22	9/01- 9/14	836	392	487
36	9/24	9/08- 9/22	728	401	423
37	10/01	9/14- 9/28	407	-	379
38	10/12	9/15-10/05	403	336	804
39	10/20	9/21-10/12	305	237	202
40	10/22	10/05-10/19	549	725	374
41	11/11	10/21-11/03	848	892	2778
42	11/20	10/28-11/10	995	448	651
43	11/24	11/02-11/15	1062	586	833
44	11/27	11/11-11/24	824	484	1061
45	12/10	11/17-11/30	1454	512	555
46	12/12	11/24-12/07	656	606	469
47	12/21	12/04-12/17	1008	872	1827
48	12/26	12/08-12/21	1382	702	1212

## 幾何学的衛星データ整約システム

## GEOMETRIC ANALYSIS OF GEODETIC SATELLITE DATA

The observation of the Japanese geodetic satellite Ajisai is being carried out in order to determine the geodetic positions of the first order control points relative to the fiducial point in the construction of the marine geodetic control network around Japan. We describe the outline of a geometric analysis system for the observation data consisting of both photographic and laser ranging measurements.

**Key words :** geodetic satellite Ajisai - photographic direction observation - satellite laser ranging (SLR) - geometric analysis

国産測地衛星「あじさい」は世界で初めて、レーザー光による測距観測、写真による方向観測の両方を可能にした衛星であり、これにより、単純な幾何学的原理に従って2地点間の相対位置を決定することができる。「あじさい」による測地観測の解析法には種々なものが考えられるが、最も基本的なものとして、本幾何学的解析が行われなければならない。海洋測地の推進計画においては、このため、固定式及び可搬式の人工衛星レーザー測距装置及び衛星方位測定装置を整備し、下里水路観測所内の本土基準点と離島等に設置した一次基準点で同時に「あじさい」のレーザー測距観測、写真方向観測を実施している。本稿では、当観測で得られたデータを解析して本土基準点に対する一次基準点の位置を決定する整約システムについて概要を述べる。

## 1. 幾何学的衛星データ整約法の原理

この整約法の特長は原理の単純さにある。その原理はきわめて簡単明快であり、多言を要しない。すなわち、既知点及び未知点の両点から同時に「あじさい」のレーザー光による測距(SLR)観測及び写真による方向観測を行う。これによって、既知点及び未知点から「あじさい」までのベクトルがそれぞれ得られる。それらを $r_A$ 、 $r_B$ とすると、既知点に対する未知点の相対位置 $r_{AB}$ は

$$r_{AB} = r_B - r_A$$

として求められる。

ここに、「同時」の意味であるが、観測は厳密に同時である必要はない。2地点での写真の露光時間(撮影開始時刻から終了時刻まで)がかなり十分にオーバーラップしていればよい。また、両地点におけるレーザー測距観測もこの時間をカバーしていなければならない。しかし、レーザー測距は衛星の通過中ずっと行われるのが原則なので事実上自動的にこの条件は満たされる。

次に、「あじさい」の発光時刻については、それぞれの地点で精密に測定する必要がある。発光は太陽の反射によるものであり、受光時刻は観測地点ごとに全く独立である。レーザー測距についても各地点で各ショットの正確な時刻の記録が必要である。時刻測定の精度は、衛星が約8 km/秒で動くことを考えると、1 cmの精度の測地に対しては1  $\mu$ s、10 cmの精度に対しては10  $\mu$ s程度が要求される。

## 2. 観測機器・観測データ

幾何学的衛星データ整約のために必要なデータは既知点及び未知点におけるレーザー測距データ及び写真方向データである。このため、両点にそれぞれレーザー測距装置と方向測定装置が必要である。

海洋測地の推進計画においては、既知点は下里水路観測所に置かれている。ここには固定式レーザー測距装置と固定式衛星方位測定装置が設置されている。未知点は離島等に置かれる一次基準点である。ここには可搬式レーザー測距装置及び可搬式衛星方位測定装置を運び込んで観測を実施する。

これら4種の観測機器のうち、固定式及び可搬式レーザー測距装置については既に詳細な紹介が本水路部観測報告になされている。また、固定式衛星方位測定装置については本号に解説がある(50ページ)。

可搬式衛星方位測定装置は、航法測地課が以前から保有していた天体カメラに、昭和62年度に乾板取枠を取り付けるなどの改造を施したものをを用いている。本カメラのレンズの口径は12.5cm、焦点距離は75cmである。

得られる観測データのうち、レーザー測距データについては、これまでに本水路部観測報告をふくむ多くの文献で述べられているのでここでは省略し、写真方向観測データについて概説する。本データは赤道儀式架台上に搭載した方位測定装置(一種の天体カメラ)により、測地衛星「あじさい」の通過を撮影した写真乾板(サイズは5インチ×7インチ)である。赤道儀は恒星の運動に同期して運転される。したがって、恒星は点像に写る。一方、測地衛星「あじさい」の像は、それが点滅しながら飛んでいるため、軌跡に沿った点像の列として得られる。撮影された写真乾板の例は本号58ページに掲載されている。

なお、これらの衛星の点像に対応する発光時刻のデータは録時装置により得られる。録時装置は、衛星方位測定装置には付属してなくて、レーザー測距装置内に組み込まれている(可搬式)か、あるいは同装置に同架されている(固定式)。各点像と記録された各発光時刻との対応づけについては後述する。

## 3. 写真乾板の読み取り

乾板上には恒星の像と衛星の点像の列とが写し込まれている。恒星のうち、比較的明るい、SAO星表に位置の掲載されている星を1枚の乾板につき約30個選び出し、これを参照星とする。参照星は乾板上、光軸中心から半径3cm程度の円内に、なるべく一様を選ぶ。

これらの参照星及び衛星の点像を座標読取装置によって読み取る。このほかに、乾板の4隅の座標値を読む。これは後に、カメラの光軸中心に近い点に乾板原点を定義するとき必要になるためである。

座標値は相対的なものであり、座標の原点、座標軸の向き、座標のスケールは任意でよい。したがって、乾板はどのような座標読取装置に、どのように設置して読み取ってもよい。しかし、言うまでもないことであるが、1枚の乾板を読む間、座標読取装置の乾板設置台に対し、乾板を絶対に動かしてはならない。

読み取りは、参照星と衛星の各点像に対し3回行い、各読み取り値の平均を採用する。続いて、乾板を約180°回転して同じ操作を繰り返し、同様のデータ・セットを得る。それぞれについて解析を行うことにより、精度の向上が図れるほか、ゴミ等を星像と見誤ることを防止したり、星像の歪み等のため読み取り精度の出ない星を除去したりすることができる。

読み取りは0.001mmの精度でおこなう。ただし、乾板4隅の読み取り精度は1mmで十分である。乾板の4隅と乾板上の光軸中心との関係はカメラ毎にあらかじめ決定しておく。この精度も1mmで十分である。4隅の座標の読み取り値から、このように関係づけられた光軸中心の座標値( $x_c$ ,  $y_c$ )を決定し、これを乾板原点と定義して、以後の解析を行う。読み取られた座標値はフロッピーディスクに格納する。



## 4. 衛星の点像の赤経・赤緯の決定

次に、撮影された衛星点像の方向、すなわち赤経・赤緯を計算する。この部分は幾何学的衛星データ整約法の中でも最も重要な部分であり、かつ計算の大半を占めるものである。したがって、本節では、その計算過程をやや詳しく述べる。

## (1) 原点の移動

読み取られた座標値は相対値であり、原点はどこにあるかを問わない。これを、乾板中心を原点とする座標系に座標変換する。つまり、原点の移動を行う。ここに乾板中心とは、3. で定義した  $(x_c, y_c)$  である。すなわち、すべての座標読み取り値に対し、

$$x' = x - x_c$$

$$y' = y - y_c$$

を計算する。以下、 $(x', y')$  を改めて  $(x, y)$  とする。また、この乾板中心を原点と呼ぶ。

## (2) 原点に対応する赤経・赤緯の決定

(i) 参照星のうち2星はあらかじめ、どの星か同定されているものとし、それらを A, B, それぞれの赤経・赤緯を  $(\alpha_A, \delta_A)$ ,  $(\alpha_B, \delta_B)$  とする(図1)。 $\alpha_A > \alpha_B$  となるように A, B を選ぶものとする(星 A, B が赤経  $24^h$  を挟んでいるときは  $\alpha_A < \alpha_B$ )。また、原点を C としたとき、 $\triangle ABC$  の中に天の北極が含まれないようにする。

(ii) 次式により、図1の平面三角形 ABC における  $\angle ACB \equiv C'$  を求める。

$$\cos C' = \frac{\overline{AC}^2 + \overline{BC}^2 - \overline{AB}^2}{2 \cdot \overline{AC} \cdot \overline{BC}}$$

(iii) 天球上、北極 P, 星 A, B によって作られる球面三角形 PAB (図2) を考える。天球は外側から見ているものとする。以下、すべて同じである。星 A, B の視位置を計算し、 $\widehat{AB}$  を c として

$$\cos c = \sin \delta_A \sin \delta_B + \cos \delta_A \cos \delta_B \cos(\alpha_A - \alpha_B)$$

により c を、また、 $\angle PAB$  を  $A_1$  として

$$\tan A_1 = \frac{\sin \delta_B \sin(\alpha_A - \alpha_B)}{\sin \delta_B \cos \delta_A - \cos \delta_B \sin \delta_A \cos(\alpha_A - \alpha_B)}$$

により  $A_1$  を求める(分母が負のときは  $A_1 > 90^\circ$  とする)。

(iv) 天球上、星 A, B 及び乾板原点 C に対応する点(その赤経・赤緯を  $(\alpha_c, \delta_c)$  とする) によって作られる球面

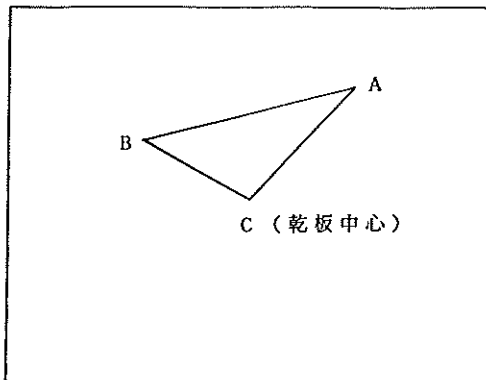

Figure 1. Triangle ABC on the photographic plate

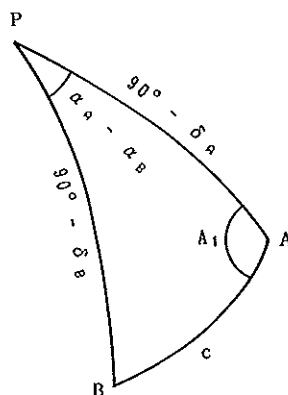

Figure 2. Spherical triangle PAB

三角形 ABC を考える (図 3)。

$\overline{AB}$  を  $m$ ,  $c$  をラジアンで表し,  $F = \overline{AB}/c$  により  $F$  を定義すると

$$a = \frac{\overline{BC}}{F} \quad b = \frac{\overline{AC}}{F}$$

によってほぼ  $a \equiv \widehat{BC}$ ,  $b \equiv \widehat{AC}$  が表される。  $F$  はほぼ  $m$  で表した衛星カメラの焦点距離に等しい。

また,  $C$  は図 1 の平面三角形の  $C'$  に等しく,

$$\frac{\sin A}{\sin a} = \frac{\sin C}{\sin c}$$

により,  $A$  が求められる。

(v) 球面三角形 PAC において (図 4)

$$\sin \delta_c = \sin \delta_a \cos b + \cos \delta_a \sin b \cos(A_1 \pm A)$$

$$\frac{\sin(\alpha_a - \alpha_c)}{\sin b} = \frac{\sin(A_1 \pm A)}{\cos \delta_c}$$

により  $(\alpha_c, \delta_c)$  を求める。

$A_1 \pm A$  における複号は,  $C$  が大円  $\widehat{AB}$  に対し  $P$  と同じ側にあるか (このとき-), 異なる側にあるか (このとき+) により判断する。これは前もって, 人間の目で判断しておき, 入力しておくものとする。なお,  $A_1 - A < 0$  または,  $A_1 + A > 180^\circ$  のときは  $\alpha_c > \alpha_a$  となる。

こうして求められた  $(\alpha_c, \delta_c)$  はいろいろな原因により厳密に  $C$  に対応する赤経・赤緯ではない。しかし, 最終的に原点の役割をするのは  $C$  ではなく, この  $(\alpha_c, \delta_c)$  に対応する乾板上の点 ( $C$  にきわめて近い) である。

(3) 真北の決定

(i) 図 5 で  $\overrightarrow{CA}$  の方向角, つまり  $\angle PCA$  を  $C_1$  とし,

$$\sin C_1 \sin b = \cos \delta_a \sin(\alpha_a - \alpha_c)$$

$$\cos C_1 \sin b = \sin \delta_a \cos \delta_c - \cos \delta_a \sin \delta_c \cos(\alpha_a - \alpha_c)$$

により  $C_1$  を求める。  $\sin b > 0$  なので  $C_1$  の象限は決定される。

ただし,  $C_1$  は,  $\overrightarrow{CP}$  から時計回りに測られる。

(ii) 乾板上,  $y$  軸 ( $y$  座標の読取値の増える方向) と  $\overrightarrow{CA}$  の方向のなす角を  $C_2$  ( $y$  軸より時計回りに測る) とすると,

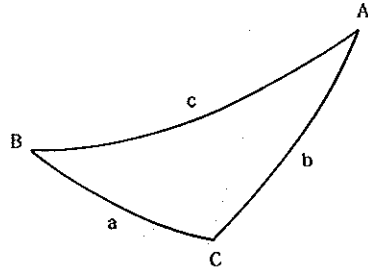

Figure 3. Spherical triangle ABC

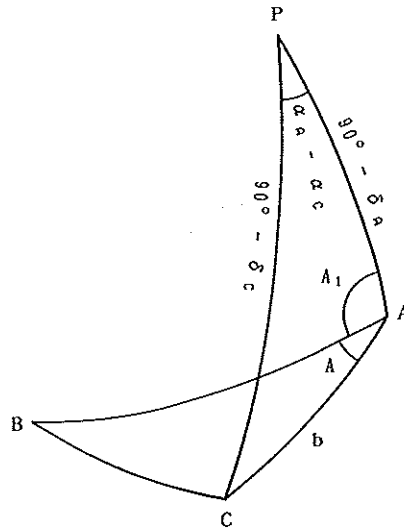

Figure 4. Spherical triangle ABC and PAC

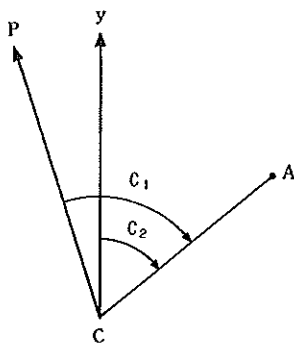

Figure 5. Direction of North Pole

$$\tan C_2 = \frac{x_A}{y_A}$$

## (4) 座標の回転

(i) 乾板原点 C を通る子午線の北の方向が新しい y 軸となるように座標系を回転する。図 5 に示されるように、 $\vec{CP}$  を新しい y 軸とするには、座標系を反時計回りに  $C_2 - C_1$  だけ回転すればよい。

(ii)  $\theta = C_2 - C_1$  とし、

$$x' = x \cos \theta + y \sin \theta$$

$$y' = -x \sin \theta + y \cos \theta$$

により、 $(x, y)$  を  $(x', y')$  に変換し、変換したものを改めて  $(x, y)$  とする。

以上により、参照星及び衛星の点像の座標読取値は、

C を原点とし、北の方向を y 軸とする座標に変換され、また、乾板原点 C (のすぐ近傍の点) に対応する  $(\alpha_c, \delta_c)$  も求められた。

## (5) 参照星の同定

(i) A, B 以外の参照星の 1 つを D とし、この星の、本節(1), (4)の変換を行った座標を  $(x_D, y_D)$  とする。ただし、単位は F とする。その赤経・赤緯を  $(\alpha_D, \delta_D)$  とすると

$$\tan(\alpha_D - \alpha_c) = \frac{x \sec \delta_c}{1 - y \tan \delta_c}$$

$$\cot \delta_D \sin(\alpha_D - \alpha_c) = \frac{x \sec \delta_c}{y + \tan \delta_c}$$

により、 $(\alpha_D, \delta_D)$  が与えられる。

(ii) 星表の中から、赤経・赤緯の値が  $(\alpha_D, \delta_D)$  に近い星を捜す。1' 以内に星があれば、求めるものとする。なお、この場合、星表から計算する星の位置は視位置である必要はなく、観測時の平均位置 (平位) で十分である。このようにして、A, B 以外のすべての参照星の同定を行う。

## (iii) 参照星の視位置の計算

A, B を含むすべての参照星の視位置を計算する。このとき、次の式で与えられる星の位置の精度をあわせて計算する。

$$\epsilon_c^2 = \sigma^2 + \sigma'^2 + \sigma_\mu^2 (t - t_0)^2 + \sigma_\mu'^2 (t - t_0)^2$$

ただし、t は衛星の写真撮影を行った観測年 (月、日は概略の年の小数に直す)、 $t_0$  は当該参照星の観測元期である。

## (6) 標準座標への変換

標準座標とは星の視位置  $(\alpha, \delta)$  から次の式により計算される  $(\xi, \eta)$  である。

$$\cot q = \cot \delta \cos(\alpha - \alpha_c) \quad (-90^\circ \leq q \leq 90^\circ)$$

$$\eta = \tan(q - \delta_c)$$

$$\xi = \frac{\cos q \tan(\alpha - \alpha_c)}{\cos(q - \delta_c)}$$

( $\xi, \eta$ )は、天球と点( $\alpha_c, \delta_c$ )で接する平面上に天球の中心から天球を投影したときの星( $\alpha, \delta$ )の座標になっている。これは、この星の、本節(1), (4)の変換を行った後の、Fを単位に表された乾板上の座標値(x, y)に近い。しかし、(x, y)とは次のようないくつかの点で異なっている。

a. スケールの違い：( $\xi, \eta$ )がラジアンで表され、(x, y)が衛星カメラの真の焦点距離を単位に表されていれば両者のスケールは一致するが、Fの誤差等により、厳密には一致しない。

b. ( $\xi, \eta$ )は、乾板原点( $\alpha_c, \delta_c$ )が衛星カメラの光軸と一致し、かつ乾板が光軸に垂直なときに星の写像の座標を表すが、実際には必ずしもこの条件は満たされていない。さらに、これまでの計算で求めた( $\alpha_c, \delta_c$ )は厳密にはCに対応する点の赤経・赤緯ではなかった(本節(2)の最後を参照)。

c. カメラのレンズの取差により、一般に乾板に写影された像は歪みを持っている。

d. 大気差の影響：恒星の視位置には大気差の影響を考慮していない。大気差の大きさの絶対量そのものは問題とならないが、乾板の写野内における大気差の差違が影響する。

e. 光行差の不完全さ：年周光行差は参照星の視位置計算の中に含まれているが、日周光行差は計算されていない。この場合も乾板内における光行差の相対的な差のみが問題となる。

これらをすべて完全にしたものが標準座標( $\xi, \eta$ )であり、これと(x, y)との関係を知ることが必要である。

### (7) プレート・コンスタントの決定

#### (i) 観測方程式

( $\xi, \eta$ )と(x, y)の間には

$$\xi - x = a + bx + cy + dx^2 + exy + fy^2$$

$$\eta - y = g + hx + iy + jx^2 + kxy + ly^2$$

なる関係があると考え、これを観測方程式とする。未知量はa~lで、いずれも小さい量であり、これがプレート・コンスタントである。参照星1個につき2個の観測方程式が得られることになる。このうち、 $\xi - x$ の方程式についてはg~lの係数は0、 $\eta - y$ の方程式についてはa~fの係数は0である。

#### (ii) 最小自乗法による解

全参照星の観測方程式から正規方程式を作る。ただし、観測方程式には、参照星の座標読取値の標準偏差及び恒星位置に含まれる誤差により次式で与えられる重みwをつける。

$$\left(\frac{1}{w^2}\right) = \left(\frac{\epsilon_r}{0.01\text{mm}}\right) \left(\frac{\epsilon_c}{1.0''}\right)$$

ただし、 $\epsilon_r$ は3回の座標読取値のrms、 $\epsilon_c$ は本節(5)による恒星位置の誤差である。

### (8) 衛星の点像の赤経・赤緯

#### (i) $\xi, \eta$ の決定

衛星の点像の読取値(x, y)を、上に求めたプレート・コンスタントを用いて( $\xi, \eta$ )に変換する。

#### (ii) $\alpha, \delta$ の決定

$$\tan(\alpha - \alpha_c) = \frac{\xi \sec \delta_c}{1 - \eta \tan \delta_c}$$

$$\cot \delta \sin(\alpha - \alpha_c) = \frac{\xi \sec \delta_c}{\eta + \tan \delta_c}$$

により,  $(\alpha, \delta)$  が求められる。

### 5. 衛星の方向に対する補正

上に求めた衛星の赤経・赤緯  $(\alpha, \delta)$  に対し, 次に述べる2つの補正が必要である。

#### (1) 大気屈折による方向の偏位

(i) 図6で, 観測点  $O$  から衛星  $G$  への幾何学的方向 (真の方向) は  $\vec{OG}$  である。ところが上に述べた乾板整約によって得られる方向は  $\vec{GS} (= \vec{O'S})$  である。なぜならば, 乾板整約においては, 恒星の大気屈折を受けない真の方向  $(\alpha, \delta)$  から計算した  $(\xi, \eta)$  と  $(x, y)$  とを関係づけた。

この恒星と衛星が重なったとき衛星の赤経・赤緯が  $(\alpha, \delta)$  と求まるのであるから, 衛星の方向は真の方向 (大気差を受けない方向) に等しく, それは  $\vec{O'S}$  の方向であり,  $\vec{GS}$  の方向である。

(ii)  $\vec{OG}$  の方向を求めるためには,  $\vec{O'S}$  の方向に対応する高度に  $R$  の補正をしなければならない。  $R$  は次式により求まる。

$$R = (h/r) \cos a$$

ここに  $h$  は図に示した浮き上がりの高さ  $\overline{OO'}$ ,  $a$  は衛星の高度,  $r$  は衛星までの距離である。  $R$  により,  $\vec{OG}$  の方向に対応する高度は  $\vec{O'S}$  の方向に対応する高度より常に高くなる。

$h$  は次の式により求める。

$$h = 2.41 (1 + \cot^2 a) \text{ (メートル)}$$

(iii)  $R (> 0)$  による赤経・赤緯への補正は次式により与えられる。

$$\Delta \alpha = R \sin \phi \sin H \cos a$$

$$\Delta \delta = R \left( \frac{\sin \phi \cos a}{\cos \delta} - \tan \delta \right)$$

ただし,  $\phi$  は観測点の緯度,  $H$  は衛星の地方時角である。

乾板整約によって得られた衛星の  $(\alpha, \delta)$  にこれを補正したものが, 衛星点像の幾何学的な方向 (真の方向) である。

#### (2) 衛星の中心と太陽反射像の方向の違い

(i) 「あじさい」は太陽の光を反射して光っている。このとき, 「あじさい」の直径が2.15メートルあるため, 衛星の表面上, 太陽の映っている点と衛星中心の方向とは少しずれる。1メートルを切る精度を問題とすると

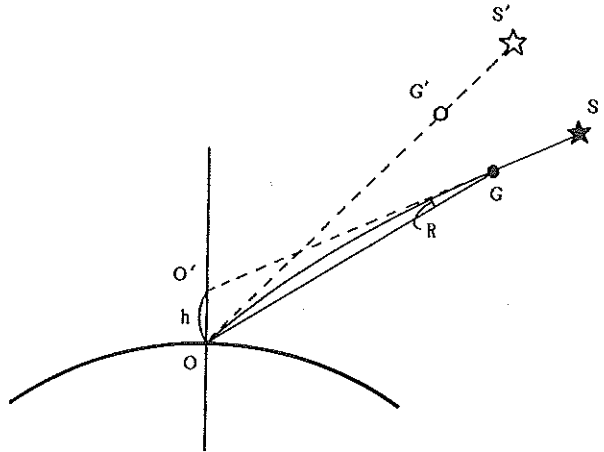

Figure 6. Correction for atmospheric refraction

きにはこの差は無視できない。

(ii) 図7・aは天球を内から見た図である。Gを「あじさい」の中心、Sを太陽とし、観測点から見たそれぞれの赤経・赤緯を $(\alpha_G, \delta_G)$ 、 $(\alpha_S, \delta_S)$ とする。GとSの離角をD、Gから見たSの方向角をPとすると、D、Pは次式から求められる。

$$\sin D \sin P = \cos \delta_S \sin(\alpha_S - \alpha_G)$$

$$\sin D \cos P = \sin \delta_S \cos \delta_G - \cos \delta_S \sin \delta_G \cos(\alpha_S - \alpha_G)$$

$$\cos D = \sin \delta_S \sin \delta_G + \cos \delta_S \cos \delta_G \cos(\alpha_S - \alpha_G)$$

観測点から見て太陽の像が衛星の表面に映っている点をLとすると、LはGS上にある。次に、図7・bは衛

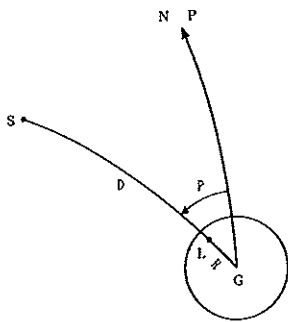

Figure 7.a. Solar image on satellite surface

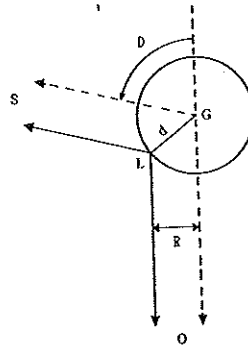

Figure 7.b. Correction for offset of solar image

星の中心G、太陽S、観測点Oを含む平面である。 $\overline{GL}=d$ とすると、図から明らかなように、

$$R = \frac{d \sin((180^\circ - D)/2)}{r} = \frac{d}{r} \cos\left(\frac{D}{2}\right)$$

である。ただし、dは衛星の半径、rは衛星までの距離である。

(iii) これを用いて、太陽反射像の $(\alpha_L, \delta_L)$ から、衛星中心の $(\alpha_G, \delta_G)$ への引き直し量は

$$\Delta\alpha = \alpha_G - \alpha_L = -\frac{R \cos P}{\cos \delta_L}$$

$$\Delta\delta = \delta_G - \delta_L = -R \sin P$$

となる。

以下の解析においては衛星中心の方向と距離を扱うので、上で求めた衛星点像の $(\alpha_L, \delta_L)$ にこの補正を施す必要がある。

## 6. 発光時刻データとの照合

衛星点像の各点に対する発光時刻はレーザー測距装置に付属した発光時刻記録装置により測られる。ところが、記録された時刻データのどの記録がどの点像に対応するかは直接にはわからない。これを対応づけるためには次のようにする。

衛星写真データと同時に得られているレーザー測距データを、各国の同時期のデータと合わせて解析することにより、衛星の軌道が精密に決定される。これから、任意の時刻の衛星の地心座標、したがって、観測点から見た衛星の赤経・赤緯が決定できる。この赤経・赤緯はそれほど高精度のものでなくてもよいが、予報値では少し不十分である。この赤経・赤緯( $\alpha'_0, \delta'_0$ )と、乾板整約により得られた( $\alpha_0, \delta_0$ )の値の近いものを見つかることにより、容易に両者を対応づけることが可能である。この結果、各発光時刻とそれぞれに対する衛星の方向( $\alpha, \delta$ )というデータのセットが得られる(以下、添字Gは省略する)。

## 7. 2地点の相対位置の決定

このようにして得られる本土基準点と一次基準点のデータ・セットは、時刻引数が同じでない。観測される発光時刻は場所によって異なるからである。ただし、両点では数秒にわたって観測期間がオーバーラップしている。

これを、両者が同じ時刻引数を持つように一方のデータを他方の時刻に補間する。ここでは、一次基準点におけるデータを本土基準点で観測された発光時刻に補間するものとする。この結果、同じ時刻における、両観測点からの衛星の方向( $\alpha, \delta$ )が得られる。一方、両観測点でのレーザー測距データも、同じ時刻引数に補間する。

以上より、同時刻における、両観測点からの衛星までの距離と方向、すなわち1. で述べたベクトル $r_A, r_B$ が得られ、それにより両観測点間の相対位置ベクトル $r_{AB}$ が求められる。

ここまでのところ、ベクトル $r_A, r_B, r_{AB}$ は、瞬時の天の赤道と春分点に基いた空間座標系で表されている。これを、地球の赤道とグリニッジ子午線方向を基準にした地球固定座標に変換する。これは通常の方法に従って行えばいいので説明は省略する。

相対位置ベクトル $r_{AB}$ が地球固定座標系で求めれば、本土基準点の経緯度を既知として、一次基準点の経緯度を容易に計算することができる。

以上の幾何学的衛星データ整約システムの全体の流れを図8に示す。

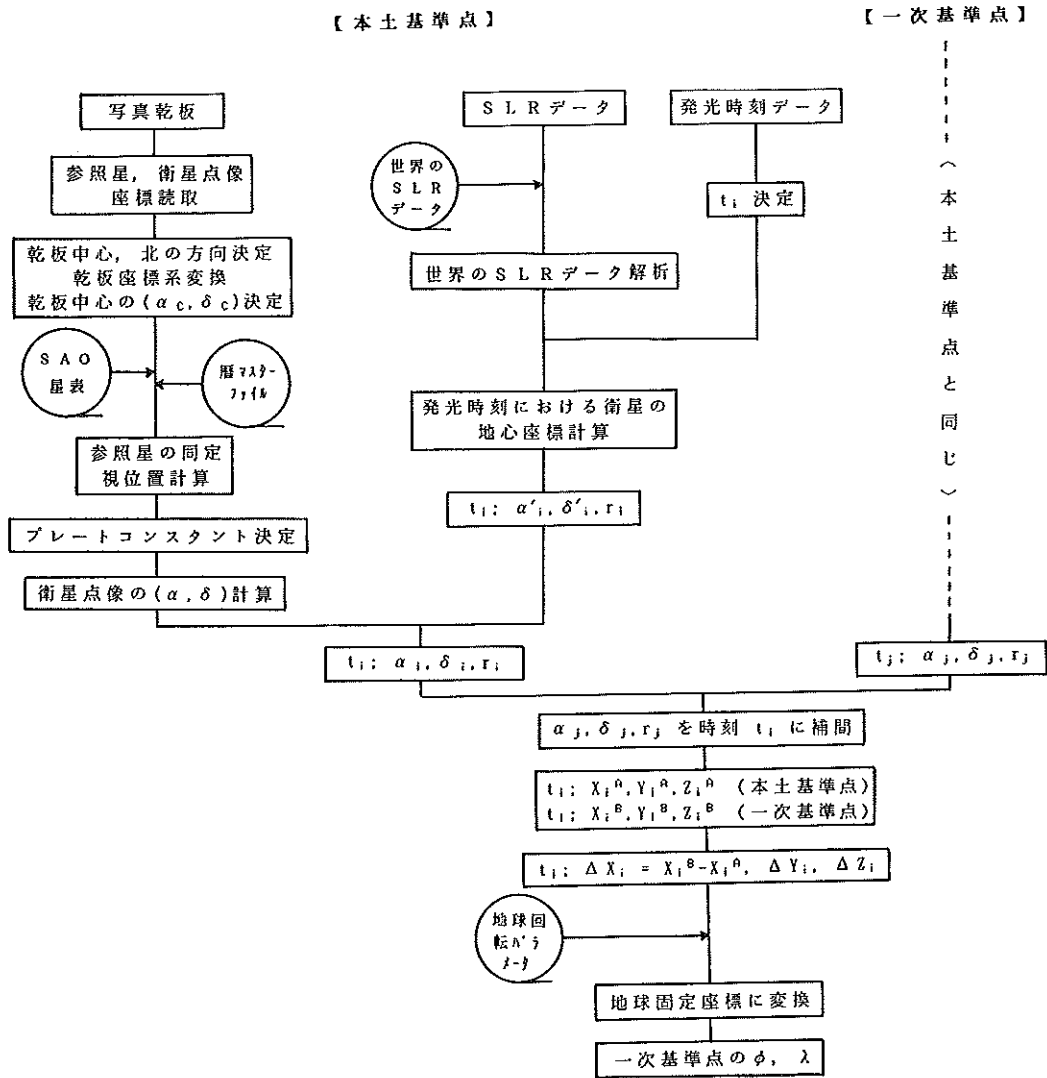

Figure 8. Total flow of geometric analysis of satellite data



## 8. 絶対経度

6.で述べたように、衛星のレーザー測距データからも観測点から見た衛星の赤経・赤緯( $\alpha'$ ,  $\delta'$ )が得られる。これと、乾板を解析して得られる( $\alpha$ ,  $\delta$ )との関係はどうなっているのだろうか。

( $\alpha'$ ,  $\delta'$ )を計算するためには観測点の経緯度が必要である。このとき使われる経緯度は世界のSLR観測網が採用しているシステムによる値であって、内部的には高精度にコンシステントであるが、その経度は必ずしもグリニッジ子午線方向(本初子午線)を基準としたものにはなっていないと考えられている。そうすると $\alpha'$ と $\alpha$ は一致しない。逆に、これが一致するようにSLR観測網の経度のシステムを改正し、本初子午線を基準とする経度、すなわち絶対経度に合致させることができる。

これは、距離と方向がともに測れる「あじさい」の観測において初めて達成可能な、「あじさい」の持つ最も重要な役割の一つである。

本報告は久保良雄が作成した。

「南太平洋における海洋プレート形成域（リフト系）の  
解明に関する研究」における GPS 精密測位

GPS EXPERIMENT IN THE JAPAN AND FRANCE JOINT RESEARCH  
PROGRAM ON RIFT SYSTEM IN THE SOUTH PACIFIC OCEAN  
(STARMER PROJECT)

The Hydrographic Department of Japan (JHD) is joining to the research program on rift system in the South Pacific Ocean which is promoted by the Science and Technology Agency of Japan (STA) and the France Institute of Research and Exploitation of Marine (IFREMER). In this project, JHD took charge of precise positioning in the research area and analyzing sea bottom topography of the North Fiji Basin area.

This report reviews some results on the precise positioning by GPS observation during the cruise in 1987 as follows :

- 1) Design of the precise positioning system
- 2) Research in North Fiji Basin area
- 3) Experimental observation between Tokyo and Okinawa.

**Key words :** GPS precise positioning - Rift System

#### 概 要

水路部では1987年から1989年までを第I期として計画されている標記研究（科学技術振興調整費による）に参加し、海底精密地形の調査、研究を行うこととしている。本報告では、初年度である1987年度に実施した作業のうち、航法測地課で担当した人工衛星を用いた精密測位観測について記述する。当課で実施した主な作業は以下のとおりである。

- 1) 精密測位システムの整備
- 2) 南太平洋（北フィジー海盆域）における調査
- 3) 東京～沖縄試験観測

#### 1. 精密測位システムの整備

測位方法が乏しく、正確な測位を行うことが困難な南太平洋海域でシーブームマッピングに必要な精度で測位を行うため、GPSを利用した精密測位システムを開発した。これは位置のわかっている陸上の固定点と船で衛星電波の同時観測を行い、船位を精度よく求めるものである（トランスロケーション法）。第1図に精密測位システムの全体像を示す。精密測位システムは複数の航行衛星受信装置とデータ解析装置からなっている。航行衛星受信装置は陸と船に各1台ずつあり、ここで毎秒観測データが磁気媒体（フロッピーディスク等）に記録される。航行衛星受信装置の構成を第1表に、仕様を第2表に示す。データ解析装置は記録されたデータをトランスロケーション法により後処理して精密な船位を決定するものである。

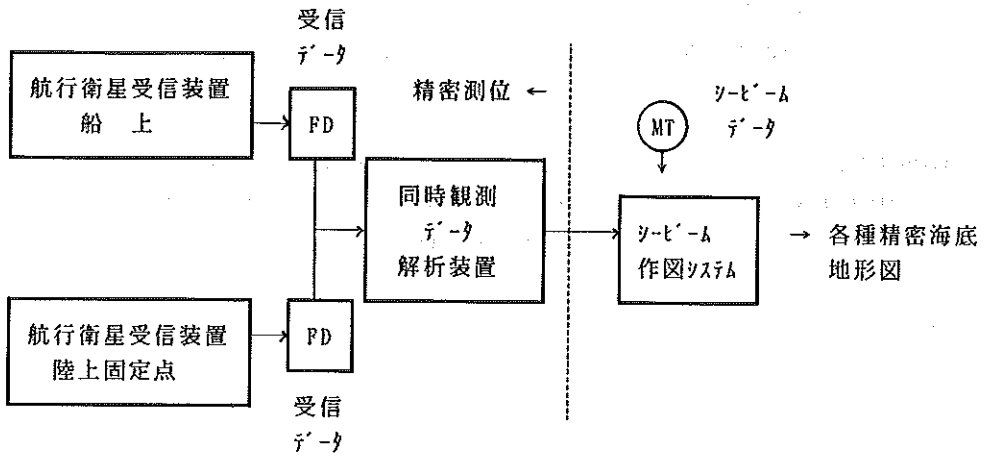

Figure 1. Precise positioning system

Table 1. GPS Precise Positioning System

名 称	規 格	数 量
受信機	NDR-904A	1
受信アンテナ	NAY-904	1
パーソナルコンピュータ	PC9801VX2	1
ディスプレイ	N5913	1
光ディスクドライバー	DD-8001	1
ハードディスクドライバ	SD-9820	1
アンテナアダプター	NJ-INCP	1
ケーブル類		
アンテナケーブル	CFQ-2522-20 他	4
電源ケーブル	CFQ-1322A	1
データケーブル	CFQ-2477	1
インタフェースケーブル	DDC-150S	1
降圧トランス	SD-21-500A	1
アンテナ用三脚		1
附属品		若干
取扱説明書		1

Table 2. Specification of the GPS receiver

1	精 度	
(1)	位 置	100m 2D RMS (PDOP ≤ 3) : システム完成時
(2)	速 度	0.9m/SEC ( " ) : "
(3)	移動方位	1.7 (120km/Hで) ( " ) : "
2	受信周波数	: 1575.42MHz ± 1MHz (L1) C/A コード
3	受信感度	: -130dBm
4	ダイナミックレンジ	: 25dB
5	信号捕捉・追尾	: コンピュータ制御による完全自動
6	測定時間間隔	: 1秒
7	同時受信衛星数	: 最大4衛星
8	PPS出力 (1パルス/秒)	
(1)	精 度	200 nsec (但し, GPS時に同期)
(2)	立上り時間	100 nsec
(3)	パルス幅	5~30 μsec
(4)	出力仕様	2.5V (50Ωで)
9	出力データ	
	GPSによる測定結果	
(1)	位 置 (緯度, 経度, 高度)	
(2)	測 定 時 刻	
(3)	疑似距離データ	
(4)	軌道データ (アルマナック, エフェメリス)	
(5)	受信ステータス	
(6)	そ の 他	
10	入力データ	
	GPSの受信測定のための初期データおよび2次測位のための高度データ	
(1)	緯度, 経度 (精度1°以内)	
(2)	高度 (3次元測位用初期値の場合は精度1000m以内)	
(3)	日付, 時間 (UTC, 精度10分以内)	
(4)	衛星選択	
11	電 源	: AC100V, 125W以下
12	環境条件	
動作温度	アンテナ	-25°C ~ +75°C
	その他	-20°C ~ +60°C
保存温度		-40°C ~ +80°C
湿 度		95% (35°C) 以下
振 動		5~100Hz, 0.5G 以下
		100~200Hz, 2G 以下
衝 撃		40G 以下

## 2. 南太平洋（北フィジー海盆域）における調査

作業実験船「かいよう」によって行われた南太平洋北フィジー海盆域のリフト系の調査の概要、及び同海域で実施したGPSによる精密測位観測の結果について述べる。

## 1) 作業概要

期 間	昭和62年11月25日（成田発）から 昭和63年1月6日（成田着）まで 43日間 観測員の往復は航空機によった。
作業区域	海上班 南太平洋北フィジー海盆域（第2図） 陸上班 仏領ニューカレドニア
作業実験船	「かいよう」 2,849G/T 海洋科学技術センター所属
基地港及び寄港地	横須賀（海洋科学技術センター専用岸壁） ニューカレドニア島（仏領）ヌーメア港 フィジー国スバ港
調査項目	「かいよう」搭載のシービーム装置による海底地形調査及び人工衛星を用いた精密測位観測
担当者	海上班 海洋調査課 岩渕 洋 陸上班 航法測地課 竹村 武彦（科学技術庁併任）

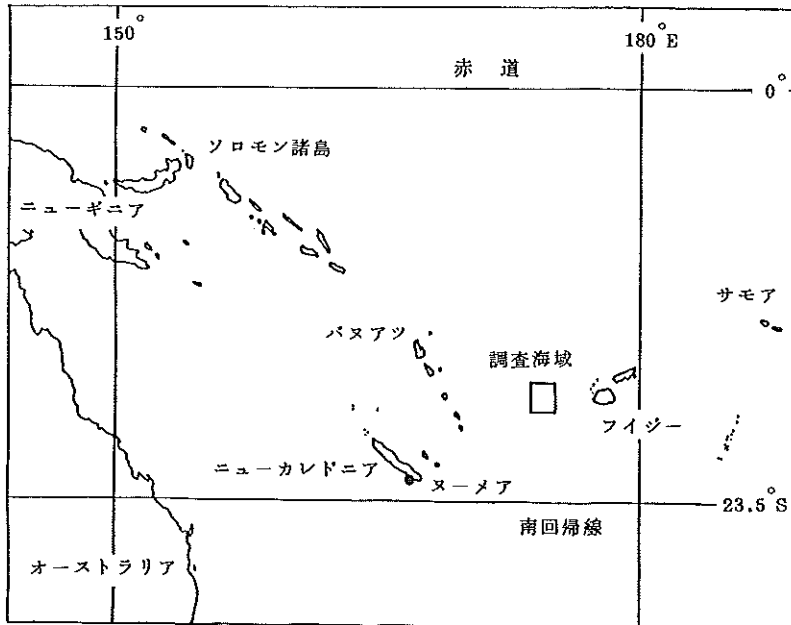

Figure 2. Survey area of the South Pacific Ocean

## GPSを用いた精密測位観測

船上局として作業実験船「かいよう」に、また陸上局としてニューカレドニア（仏領）ヌーメアに GPS 受信機を設置して、リフト系作業期間中 GPS 衛星の同時観測を実施した。

## イ) 機器設置

船上局 アンテナ：「かいよう」頂部甲板 右舷マスト上

受信機：総合司令室

電源：精密電源(AC100V, 60Hz)

担当者：岩瀬 洋

陸上局 アンテナ：フランス海外領土科学技術局（通称 ORSTOM）ヌーメアセンター庁舎屋上  
（第3, 4図）

受信機：庁舎2階 No.88号室内

電源：商用電源 AC220V, 50Hz を降圧トランスを用い AC100V にして使用した。

担当者：竹村 武彦

使用機器 GPS 受信機(JLR-904A) 日本無線 KK 製

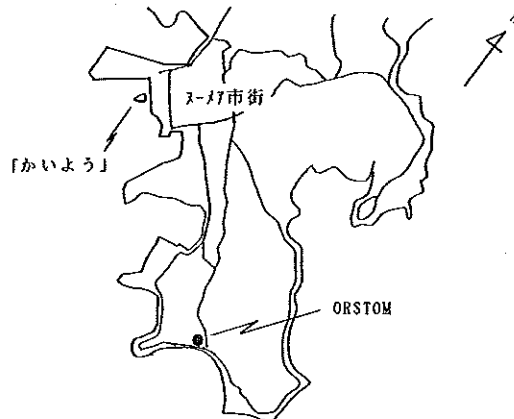

Figure 3. Noumea Cedex

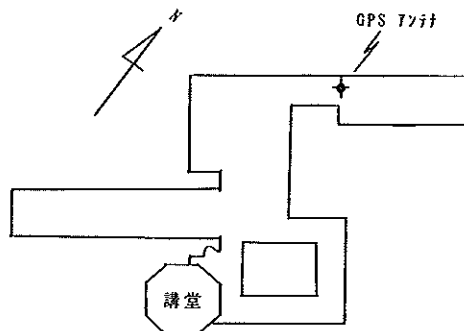

Figure 4. Plan of the ORSTOM building

## ロ) 観測

船上局, 陸上局とも11月26日から翌年1月3日まで観測を実施した。

衛星モード : 1, 2, 3, 4 衛星モード自動選択

ディスクへの出力頻度: 出力1 1秒毎→後半6秒毎

出力2 10分毎

データ記録 : 光ディスク→後半5インチフロッピーディスク

光ディスクドライバの故障のため, データ記録に5インチフロッピーディスクを使用する等, 若干の変更があった。船上局では船の振動によると思われる受信機(発振器)の故障もあり前半はデータが取れなかった。

## ハ) 航跡図の作成

GPS衛星は全部で18個打ち上げられる予定であるが, まだ打ち上げ数が少なく, 調査期間中使用可能なGPS衛星は, PRN No. (疑似雑音番号, 以後No.と記す) 3, 6, 8, 9, 11, 12, 13と全部で7個であり, またNo. 8が時々不調であった。そのため, 3衛星以上観測可能な時間は1日8時間程度で, それ以外の時間帯はNNSSと推測航法データによった。

## ニ) データ解析

データ解析はデータ編集プログラム(淵田作成)及び解析プログラム(久保作成)により行った。これは, 単独解, トランズローケーション法による解とも可能である。データ編集プログラムにより1秒毎のデータから不良データを除去し, 15秒毎のノーマルポイントデータを作成し, このデータを解析プログラムにより解析処理し結果を算出した。

陸上局(ヌーメア)の位置は, 取得データの単独解の平均値を用いることとし, これを基準にして船位決定を行うこととした。全部の衛星を用いた平均値は,

$$a. \quad \phi = -22^{\circ} 18' 04''.177$$

$$\lambda = +166^{\circ} 26' 41''.461$$

$$H = 71\text{m (固定; WGS84 ジオイド高 (59m) + 海面からの高さ (12m))}$$

$$n = 11626, \quad \text{RMS} = \pm 112\text{m}$$

となった。第5図に単独解の分布を示す。これによると, やや異常な分布が見られるので, 衛星について吟味し, No. 8 (水晶時計を搭載)を除去したものの, 更にNo. 6, 9 (ルビジウム時計を搭載)を除去したものについて計算し以下の結果を得た。

b. No. 8を除去した結果,

$$\phi = -22^{\circ} 18' 04''.114$$

$$\lambda = +166^{\circ} 26' 40''.133$$

$$H = 71\text{m}$$

$$n = 6568, \quad \text{RMS} = 114\text{m}$$

c. No. 6, 8, 9を除去した結果,

$$\phi = -22^{\circ} 18' 03''.593$$

$$\lambda = +166^{\circ} 26' 41''.429$$

$$H = 71\text{m}$$

$$n = 1705, \quad \text{RMS} = 21.6\text{m}$$

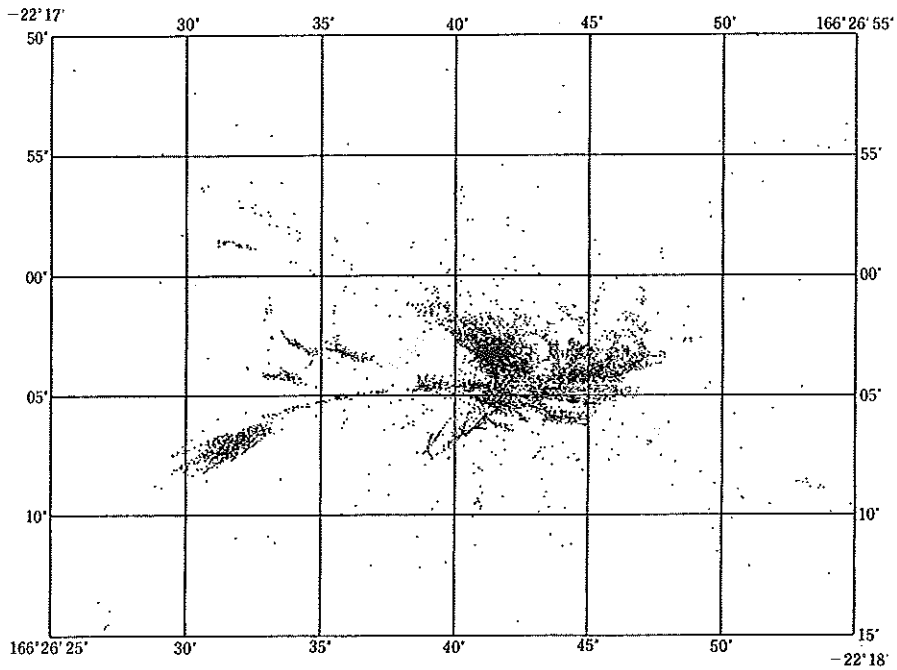

Figure 5. Distribution of the point positioning solutions at Noumea

Satellites: No. 3, 6, 8, 9, 11, 12, 13

第6図、第7図にb, cの単独解の分布を示す。No. 6, 8, 9を除去したものはRMS=21.6mと良くなっている。これらの原因については受信機によるのか、データ処理ソフトによるのか検討中である。

船位決定は、単独解、トランスロケーション法(c.の結果を基準値として使用)の両方で求めた。これらについての比較を第3表に示す。トランスロケーション法により数100mの位置の改良が見られる。第4表にトランスロケーション法、単独解、NNSSと推測航法による値の比較を掲載した。

なお、2衛星による船位決定も試みた。衛星の配置が良い場合に比較的良く決定できたものもあったが、一般には良く決まらなかった。



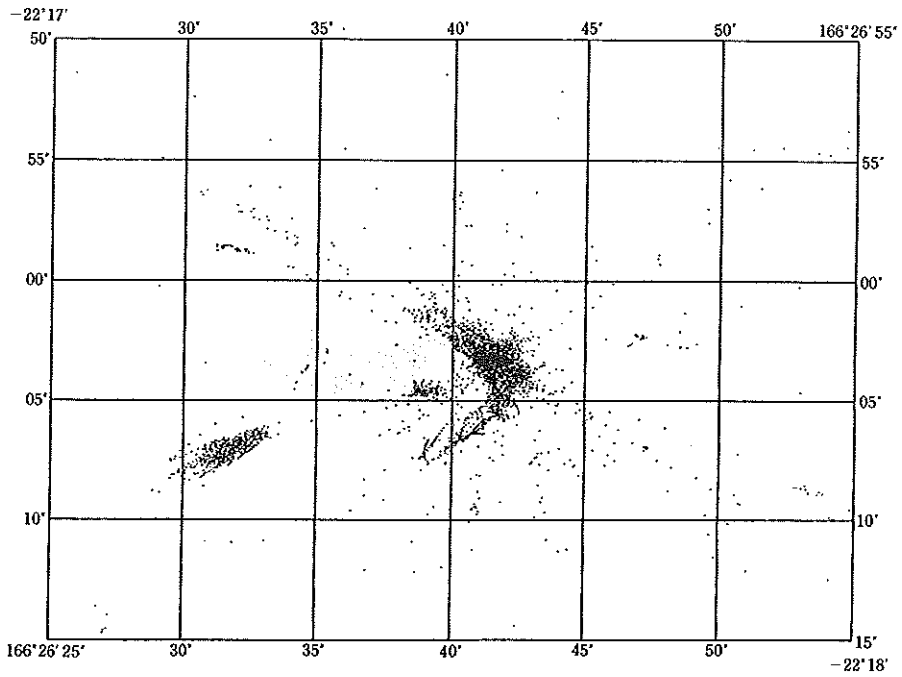

Figure 6. Distribution of the point positioning solutions at Noumea  
Satellites: No. 3, 6, 9, 11, 12, 13

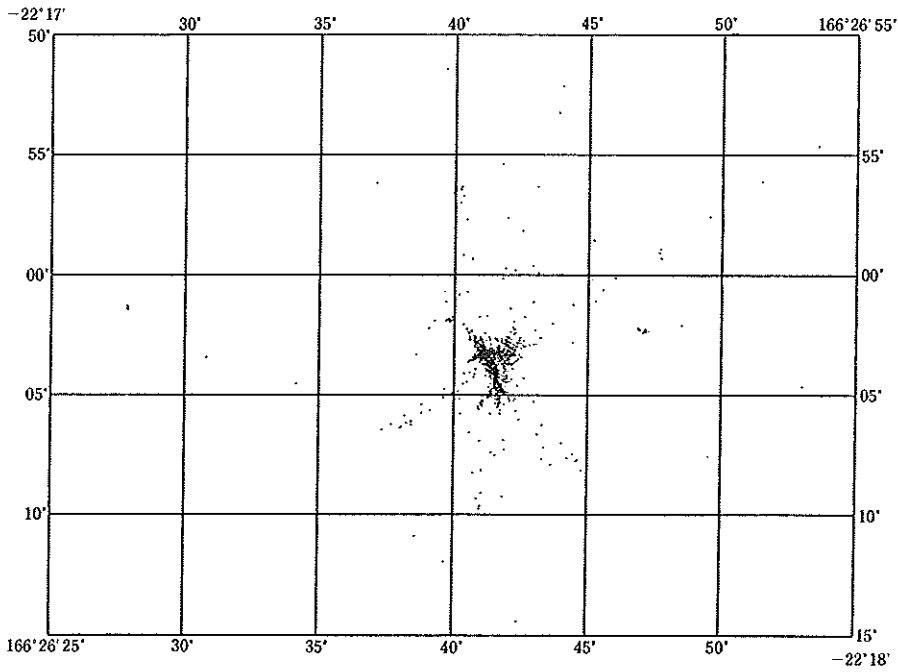

Figure 7. Distribution of the point positioning solutions at Noumea  
Satellites: No. 3, 11, 12, 13

Table 3. Comparison of point positioning and translocation

Date	Time (UTC)	Point Positioning			Trans Location			P.P. - T.L.	
		Lat		Long	Lat		Long	Delta Lat	Delta Long
		Y M D	h m s	d m s	d m s	d m s	d m s	s	s
1987 12 16	14 41 0	-17 11 23.4	176 30 05.3	-17 11 20.0	176 30 12.6	-3.3	-7.3		
1987 12 17	3 23 0	-16 35 09.1	176 15 41.8	-16 35 09.6	176 15 31.0	0.5	10.8		
1987 12 17	3 24 0	-16 35 09.1	176 15 41.3	-16 35 09.6	176 15 30.5	0.5	10.7		
1987 12 17	3 25 0	-16 35 09.5	176 15 38.7	-16 35 10.1	176 15 28.2	0.6	10.4		
1987 12 17	3 26 0	-16 35 11.0	176 15 34.8	-16 35 11.8	176 15 25.0	0.7	9.8		
1987 12 17	3 27 0	-16 35 13.0	176 15 30.8	-16 35 13.7	176 15 20.6	0.7	10.2		
1987 12 17	3 28 0	-16 35 10.1	176 15 35.9	-16 35 10.1	176 15 26.9	0.0	9.0		
1987 12 17	3 29 0	-16 35 09.8	176 15 35.1	-16 35 10.8	176 15 24.4	1.0	10.6		
1987 12 17	3 32 0	-16 35 09.2	176 15 33.7	-16 35 10.6	176 15 22.4	1.4	11.3		
1987 12 17	3 33 0	-16 35 09.0	176 15 33.4	-16 35 10.5	176 15 21.8	1.5	11.6		
1987 12 17	3 34 0	-16 35 08.9	176 15 32.9	-16 35 10.5	176 15 21.7	1.6	11.2		
1987 12 17	3 35 0			-16 35 10.7	176 15 21.4				
1987 12 17	3 36 0	-16 35 09.2	176 15 31.5	-16 35 10.8	176 15 21.0	1.7	10.4		
1987 12 17	3 37 0	-16 35 09.2	176 15 30.8	-16 35 10.9	176 15 20.4	1.7	10.3		
1987 12 17	3 38 0	-16 35 09.3	176 15 30.2	-16 35 11.1	176 15 19.8	1.7	10.4		
1987 12 17	3 39 0	-16 35 09.4	176 15 29.4	-16 35 11.2	176 15 18.9	1.8	10.5		
1987 12 17	3 40 0	-16 35 09.5	176 15 28.4	-16 35 11.3	176 15 18.0	1.8	10.4		
1987 12 17	3 51 0	-16 35 09.9	176 15 16.2	-16 35 13.0	176 15 04.7	3.1	11.5		
1987 12 17	3 52 0	-16 35 10.6	176 15 15.5	-16 35 13.8	176 15 03.7	3.2	11.8		
1987 12 17	3 53 0	-16 35 11.3	176 15 14.5	-16 35 14.6	176 15 02.5	3.4	12.0		
1987 12 17	3 54 0	-16 35 11.1	176 15 14.9	-16 35 14.6	176 15 02.9	3.5	12.0		
1987 12 17	3 55 0	-16 35 10.9	176 15 15.0	-16 35 14.6	176 15 03.0	3.6	12.0		
1987 12 17	3 56 0	-16 35 11.2	176 15 12.9	-16 35 14.9	176 15 00.8	3.7	12.1		
1987 12 17	3 57 0	-16 35 11.9	176 15 11.8	-16 35 15.8	176 14 59.4	3.9	12.4		
1987 12 17	3 58 0	-16 35 14.5	176 15 07.9	-16 35 18.5	176 14 55.6	3.9	12.2		
1987 12 17	3 59 0	-16 35 16.8	176 15 06.4	-16 35 20.7	176 14 54.9	3.9	11.5		
1987 12 17	4 0 0	-16 35 19.3	176 15 04.0	-16 35 23.5	176 14 51.8	4.2	12.1		
1987 12 17	4 1 0	-16 35 26.6	176 14 50.1	-16 35 27.0	176 14 44.3	0.4	5.9		
1987 12 17	4 2 0	-16 35 29.5	176 14 47.2	-16 35 30.0	176 14 41.1	0.5	6.1		
1987 12 17	4 3 0	-16 35 32.6	176 14 43.8	-16 35 33.2	176 14 37.5	0.5	6.3		
1987 12 17	4 5 0	-16 35 38.2	176 14 36.9	-16 35 38.8	176 14 30.6	0.6	6.3		
1987 12 17	4 7 0	-16 35 43.4	176 14 30.3	-16 35 44.1	176 14 24.2	0.7	6.0		
1987 12 17	4 8 0	-16 35 45.9	176 14 26.8	-16 35 46.8	176 14 20.4	0.8	6.4		
1987 12 17	4 9 0	-16 35 48.5	176 14 23.5	-16 35 49.5	176 14 16.8	1.0	6.7		
1987 12 17	4 10 0	-16 35 51.0	176 14 20.2	-16 35 52.0	176 14 13.5	1.0	6.6		
1987 12 17	9 22 0			-15 22 34.9	176 36 00.5				
1987 12 17	14 31 0	-17 03 53.1	176 16 36.0	-17 03 49.2	176 16 41.9	-3.9	-5.9		
1987 12 17	14 32 0	-17 03 55.2	176 16 25.7	-17 03 51.4	176 16 31.6	-3.8	-5.9		
1987 12 17	14 33 0	-17 03 57.5	176 16 15.5	-17 03 53.9	176 16 21.3	-3.6	-5.9		
1987 12 17	14 34 0			-17 03 55.9	176 16 11.4				
1987 12 17	14 35 0	-17 04 01.6	176 15 55.1	-17 03 57.7	176 16 01.6	-3.9	-6.5		
1987 12 17	14 37 0	-17 04 05.5	176 15 34.4	-17 04 01.5	176 15 41.0	-3.9	-6.6		
1987 12 18	3 18 0	-16 59 30.1	174 45 35.1	-16 59 28.5	174 45 23.4	-1.5	11.7		
1987 12 18	3 36 0	-16 57 10.2	174 43 20.7	-16 57 10.0	174 43 11.8	-0.3	8.9		
1987 12 18	3 37 0	-16 57 02.7	174 43 13.7	-16 57 02.5	174 43 04.8	-0.2	8.9		
1987 12 18	3 38 0	-16 56 55.2	174 43 06.7	-16 56 55.0	174 42 57.8	-0.2	8.9		
1987 12 18	3 40 0	-16 56 40.0	174 42 52.7	-16 56 39.9	174 42 44.1	-0.1	8.6		
1987 12 18	3 41 0	-16 56 32.3	174 42 45.5	-16 56 32.2	174 42 37.1	-0.1	8.4		
1987 12 18	3 42 0	-16 56 24.6	174 42 38.2	-16 56 24.8	174 42 29.9	0.1	8.3		
1987 12 18	3 47 0	-16 55 47.1	174 42 03.5	-16 55 47.6	174 41 55.4	0.4	8.1		
1987 12 18	3 48 0	-16 55 39.6	174 41 56.8	-16 55 40.2	174 41 48.7	0.5	8.1		
1987 12 18	3 49 0	-16 55 32.2	174 41 50.2	-16 55 32.8	174 41 42.1	0.6	8.1		
1987 12 18	3 50 0	-16 55 24.8	174 41 43.6	-16 55 25.6	174 41 35.4	0.7	8.2		

Table 4. Comparison of Translocation, Point Positioning and NNSS &amp; dead reckoning

WGS-84

DATE UT	$\phi$	diff	$\lambda$	diff	Memo
M D h m s	° ' "	"	° ' "	"	
12 16 3 27 56	-18 26 39.6	-0.5	177 42 57.9	+6.5	Translocation Point Positioning NNSS & dead reck.
	-18 26 40.1	+9.3	177 43 04.4	-11.5	
	-18 26 30.3		177 42 46.4		
3 28 56	-18 26 33.3	-0.5	177 42 49.8	+5.8	diff Point Positioning -Translocation NNSS & dead reck. -Translocation
	-18 26 33.8	+5.6	177 42 55.6	-7.0	
	-18 26 27.7		177 42 42.8		
3 29 56	-18 26 26.8	-0.7	177 42 41.5	+5.2	
	-18 26 27.5	+4.8	177 42 46.7	-6.3	
	-18 26 22.0		177 42 35.2		
12 17 4 06 41	-16 35 42.6	+0.6	176 14 25.5	+5.8	
	-16 35 42.0	-0.6	176 14 31.3	-1.9	
	-16 35 43.2		176 14 23.6		
4 07 41	-16 35 45.3	+0.7	176 14 21.6	+6.2	
	-16 35 44.6	+0.1	176 14 27.8	-0.6	
	-16 35 45.2		176 14 21.0		
4 08 41	-16 35 48.1	+1.0	176 14 18.0	+6.5	
	-16 35 47.1	+0.5	176 14 24.5	-0.1	
	-16 35 47.6		176 14 17.9		
4 09 41	-16 35 50.7	+1.0	176 14 14.5	+6.6	
	-16 35 49.7	+0.5	176 14 21.1	+0.2	
	-16 35 50.2		176 14 14.7		
12 18 3 35 56	-16 57 10.5	-0.7	174 43 11.7	-0.3	
	-16 57 11.2	-5.0	174 43 11.4	+5.6	
	-16 57 15.5		174 43 17.3		
3 36 56	-16 57 03.0	-0.7	174 43 04.7	-0.3	
	-16 57 03.7	-4.7	174 43 04.4	+6.0	
	-16 57 07.7		174 43 10.7		
3 37 56	-16 56 55.6	-0.7	174 42 57.7	-0.1	
	-16 56 56.3	-4.9	174 42 57.6	+5.7	
	-16 57 00.5		174 43 03.4		
3 46 56	-16 55 48.2	-0.6	174 41 55.1	+0.2	
	-16 55 48.8	-6.3	174 41 55.3	+6.6	
	-16 55 54.5		174 42 01.7		

## 3. 東京～沖縄試験観測

1,500km程離れた2地点東京～沖縄間で測位精度評価のための試験観測を行い、単独解、トランスロケーション法による解、NNSSによる結果(過去数年間の観測結果の平均値で決定精度は±1m, 竹村, 1983～1988)との比較を行った。

## 観測場所, 担当者

東京(築地)	水路部庁舎1号館屋上(第8図)	浅井 光一・川井 孝之
	測点標識上 0.14m (アンテナ上部までの高さ)	
沖縄(那覇)	株式会社那覇新港冷凍屋上(第9図)	竹村 武彦
	測点標識上 0.94m (アンテナ上部までの高さ)	

## 観測期間

東京(築地)	3月14日10:00～3月17日13:00
沖縄(那覇)	3月14日14:40～3月17日14:00

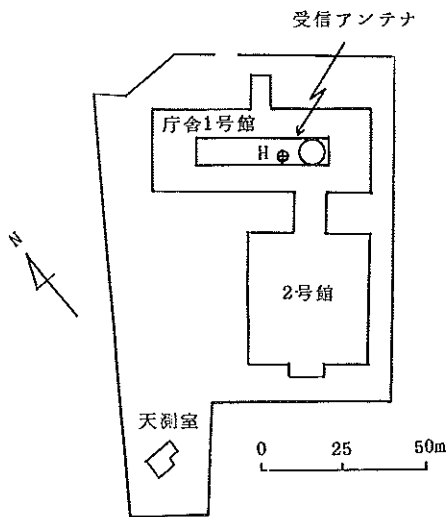

Figure 8. JHD Building (Tukizi, Tōkyō)

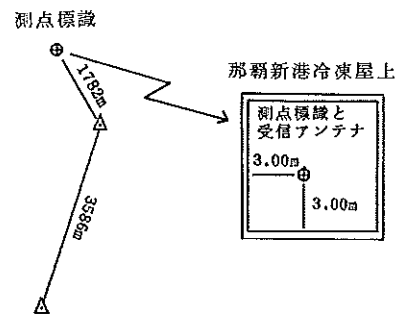

Figure 9. Naha, Okinawa Sima

結果の一部を第5表に示す。単独解と、トランスロケーション法による解の間に2"～50" (1"＝約30m)の差が見られるが、これはトランスロケーション法により2"～50"位置が改善されたことを示している。また、NNSSの結果とトランスロケーション法の結果には約1"の差が見られ、これは約1,500km離れた地点でのトランスロケーション法による位置決定精度が約1"であったことを示している。

Table 5. Comparison of Point Positioning, Translocation and NNSS at the known position (Naha)

WGS-84

Date	UT	$\phi$	diff	$\lambda$	diff	Memo	
	h m s	° ' "	"	° ' "	"		
3 15	17 08 40	26 13 48.404	53.651	127 41 07.615	42.890	単独解 トランスロケーション	
		26 14 42.055		127 40 24.725			
	17 09 40	26 13 47.989	53.785	127 41 07.191	42.182		"
		26 14 41.774		127 40 25.009			
	17 10 40	26 13 47.460	54.053	127 41 06.561	41.608		"
		26 14 41.513		127 40 24.953			
	17 11 40	26 13 47.775	53.986	127 41 05.504	40.922		"
		26 14 41.761		127 40 24.582			
	17 12 55	26 13 48.523	53.921	127 41 04.140	40.027		"
		26 14 42.444		127 40 24.113			
3 16	00 40 55	26 14 38.657	1.879	127 40 24.261	1.385	"	
		26 14 40.536		127 40 25.646			
	00 42 55	26 14 38.702	1.850	127 40 24.364	1.374		
		26 14 40.552		127 40 25.738			
トランスロケーション平均 NNSSによる結果		26 14 41.519±0.727 26 14 40.652±0.018		127 40 24.967±0.274 127 40 25.325±0.050			
トランスロケーション -NNSS		+0.867		-0.358			

あとかき

本報告は、竹村武彦が作成し、電子計算機による観測成果の算出は淵田晃一・川井孝之が担当した。本報告では昭和62年度に実施した観測について記述したが、機器を一部改良し、63年度にも引続き南太平洋のリフト系の調査を実施する予定である。したがって、本報告に記述した機器の構成等に若干の変更がありうる。

最後に本研究の推進並びに現地における観測作業に協力いただいた各位に多大の感謝を捧げる次第である。

## 参 考 文 献

Scientific Party on Board Kaiyo, 1987 : *STARMER Cruise Report, Kaiyo 87 Cruise in the North Fiji Basin.*

竹村武彦, 1983~1986 : 水路部観測報告天文測地編, 17~20.

竹村武彦, 1987 : 水路部観測報告衛星測地編, 1, 46.

平成元年3月14日印刷  
平成元年3月24日発行

---

発行者	海上保安庁 東京都千代田区霞が関2丁目1番3号 (郵便番号100) 電話 東京(03)591-6361(代)
編集者	海上保安庁水路部 東京都中央区築地5丁目3番1号 (郵便番号104) 電話 東京(03)541-3811(代)
印刷者	株式会社文秀社 東京都千代田区内神田3丁目10番7号 (郵便番号101) 電話 東京(03)254-5311(代)

---